



DIRECT  
ERGONOMICS

# Direct Ergonomics Full Catalogue October 2022

DIRECT ERGONOMICS IS AN INDIGENOUS BUSINESS  
CERTIFIED BY SUPPLY NATION

| [WWW.DIRECTERGO.COM.AU](http://WWW.DIRECTERGO.COM.AU) |  
| [SALES@DIRECTERGO.COM.AU](mailto:SALES@DIRECTERGO.COM.AU) |



# CONTENTS

|                             |       |
|-----------------------------|-------|
| Certifications              | 3     |
| Who & Why Direct Ergonomics | 4-5   |
| Services                    | 6-7   |
| Heritage                    | 8     |
| Australian Standards        | 9     |
| Colour Guides               | 10-11 |
| Delivery                    | 12    |

## Desking

17

|                           |    |
|---------------------------|----|
| Workzone Cargo            | 20 |
| Workzone Manual           | 21 |
| Workzone Electric 2C      | 22 |
| Workzone Electric 3C      | 23 |
| Workzone Pneumatic        | 24 |
| WORKZONE ELECTRIC 360     | 24 |
| Nubloc Single             | 28 |
| Nubloc Desk & Return      | 29 |
| Nubloc Shared Desk        | 30 |
| Vista Desk                | 34 |
| Vista Shared Desk         | 35 |
| Monico Loop Desk          | 39 |
| Monico Loop Desk & Return | 40 |
| Monico Loop Shared Desk   | 41 |
| MF1 Slab End Desk         | 46 |

## Task & Executive

64

|                       |    |
|-----------------------|----|
| Ezone Chair           | 65 |
| Breeze 150            | 66 |
| Uno Express           | 66 |
| Uno Classic           | 67 |
| Uno Ergo              | 67 |
| Uno Inc               | 68 |
| Evo                   | 68 |
| Breeze 600 Chair      | 69 |
| Kaz Executive Chair   | 70 |
| Genex Mesh 300 Mobile | 70 |
| Genex 600             | 71 |
| Flexi Mesh Executive  | 71 |
| Genex 200 Slimline    | 72 |
| Clam Stool Chair      | 73 |
| Lab Stool             | 73 |

## Ergonomic

48

|                               |    |
|-------------------------------|----|
| StandUp Pneumatic             | 50 |
| StandUp Electric              | 51 |
| Anti Fatigue Matt             | 52 |
| Foot Rest                     | 52 |
| StandUp Monitor Arm           | 53 |
| Slimline Monitor Arm          | 53 |
| Custom control room solutions | 53 |

## Tables

75

|                       |    |
|-----------------------|----|
| City Flip table       | 76 |
| Flexi Max Flip Table  | 77 |
| FLEXI FLIP TABLE      | 77 |
| Nubloc Table          | 78 |
| Flexi Meeting tables  | 79 |
| Blade Table           | 80 |
| Vista Bar Table       | 80 |
| Stylus Disc Table     | 81 |
| UR Profile Table      | 82 |
| Mobile Laptop Table   | 83 |
| Mini Me Portable Desk | 83 |

## Screens

55

|                          |    |
|--------------------------|----|
| Aero 50mm System         | 56 |
| Aero System              | 56 |
| CUBE 30MM SYSTEM         | 57 |
| Echo Screen System       | 58 |
| Blade Screen             | 59 |
| Plexa Screen System      | 59 |
| Plexa Room Divider       | 60 |
| Blade Room Divider       | 60 |
| Communicate Room Divider | 61 |
| Modo Pinboard            | 61 |
| Wall Mounted Pinboard    | 62 |
| Peel'N'Stick Tiles       | 62 |

## Storage

122

|                           |     |
|---------------------------|-----|
| Workzone Melamine Storage | 123 |
| Melamine Mobile Storage   | 124 |
| Workzone Steel Storage    | 126 |
| Workzone Personal Lockers | 129 |

## Components

131

|                        |     |
|------------------------|-----|
| Worktops               | 132 |
| Cable Management       | 133 |
| Power, Data & Charging | 134 |

## Visitor 85

|                   |    |
|-------------------|----|
| Sonia Chair       | 86 |
| Paris Chair       | 86 |
| Webar Chair       | 87 |
| The Pixar Chair   | 87 |
| Lola Chair        | 88 |
| Arrow Chair       | 88 |
| Game Chair        | 89 |
| Stax Chair        | 89 |
| Abby Chair        | 90 |
| Romba Chair       | 90 |
| LUNA CHAIR        | 91 |
| Genex Mesh Mobile | 91 |
| Tidy Chair        | 92 |
| Balance Chair     | 92 |
| Clue Chair        | 93 |
| Zenra Chair       | 93 |

## Healthcare 95

|                      |     |
|----------------------|-----|
| Bella Chair          | 96  |
| Woody Chair          | 96  |
| Jackal Chair         | 97  |
| Alfred Chair         | 97  |
| Zig Chair            | 98  |
| Josh Chair           | 98  |
| Rota Chair           | 99  |
| Senna Chair          | 99  |
| Vinny Chair          | 100 |
| Ambass Chair         | 100 |
| Transfusion Sofa Bed | 101 |
| Sofa Bed             | 101 |
| Sickbay Bed          | 102 |
| Foy Chair            | 102 |
| Max Beam Seating     | 103 |
| Laser Beam Seating   | 103 |
| Goldy Tub Chair      | 104 |
| Tia Tub Chair        | 104 |
| Alice Tub Chair      | 105 |
| Senna Chair          | 105 |
| Genex Mesh Mobile    | 106 |
| Pixar Chair          | 107 |
| Pixar Barstool       | 107 |

## Collaborative 109

|                  |     |
|------------------|-----|
| Focus Seating    | 110 |
| Shield Seating   | 111 |
| Flow lounge      | 112 |
| Park lounge      | 114 |
| Quiet Booth      | 116 |
| Sara Seating     | 117 |
| Arc Movement     | 117 |
| Pebble Ottoman   | 118 |
| Otta Ottoman Mix | 119 |
| Vera Lounge      | 120 |
| Samal Lounge     | 120 |

# CERTIFICATION

SPECIFIC PRODUCT IN THIS PRICEBOOK COMES WITH SOME OF THESE CERTIFICATIONS, OR CAN BE MANUFACTURED TO QUALIFY.



## Supply Nation

Supply Nation's world-leading 5-step verification process provides peace of mind by ensuring that all businesses listed on Australia's largest national directory of Aboriginal and Torres Strait Islander businesses. "Certified" means a current approved Indigenous business and certified supplier of Supply Nation meeting certification criteria.

---



## Warranty

DE Warranty promises the original purchaser that it will repair or replace with comparable product, at its option and free of charge (for material and components), any product, part or component which fails under normal use over the duration of the specified warranty term (taken from the date of purchase). Normal commercial usage is defined as the equivalent of a single shift, 40 hour work-week.

---



## ISO 14001

ISO 14001 Certification is the international standard that specifies requirements for an effective Environmental Management System (EMS). It provides a framework that DE as an organization can follow. At DE we are using this framework as an approach to continuous improvement across all environmental aspects of our business.

---



## ISO 9001

ISO 9001 Certification is the world's most widely recognized Quality Management System (QMS). At DE its our guiding principle to meet the expectations and needs of our customers through quality management systems that continually monitor and manage quality across all operations to deliver consistent performance and service.

---



## AS/NZS 4801

AS/NZS 4801 is the benchmark to assess Occupational Health & Safety Management systems for organisations. This standard contains vital information about meeting legal requirements and invaluable guidance on how to establish sustained improvement in health and safety performance in your business.

---



## GECA

GECA (The Good Environmental Choice Australia) Ecolabelling Program, operates a national third-party, independently verified ecolabel, in conformance with Environmental labels and declarations (ISO 14024), that can be applied to a wide range of products and services. This certification gives you an independent, reliable and convenient way to select DE products and services that are certified by GECA to deliver better environmental outcomes.

---



## AFRDI

AFRDI Certification is a set of standards covering strength, durability, stability and safety (and ergonomics in the case of desks and workstations). This means that DE are accountable for maintaining the quality of our products, submitting them for regular auditing to ensure they meet the highest standards for commercial use.

---



## BIFMA

BIFMA Certification focuses on safety and performance standards developed by the BIFMA Engineering Committee. The standards provide manufacturers, specifiers, and users with a common basis for evaluating safety, durability, and the structural adequacy of the specified furniture, independent of construction materials. The standards define specific tests, laboratory equipment to be used, the conditions of test, and the minimum acceptance levels to be used in evaluating these products.

---



## FSC

FSC is the leading catalyst and defining force for improved forest management and market transformation, shifting the global forest trend toward sustainable use, conservation, restoration, and respect for all.

---



## AUSTRALIAN TRUSTED TRADER

Australian Trusted Trader Certification is a standard that rewards companies showing compliant behaviour, secure supply chain with strong security practices, to enjoy a wide range of trade facilitation benefits. DE have held this status since 2017.

---



## GREENGUARD

A GREENGUARD Certification ensures that a product has met some of the world's most rigorous and comprehensive standards for low emissions of volatile organic compounds (VOCs) into indoor air. GREENGUARD Gold Certification offers certification criteria that considers safety factors to account for sensitive individuals (such as children and the elderly), and ensures that a product is acceptable for use in environments such as schools and healthcare facilities.



# WHO ARE DIRECT ERGONOMICS?

---

DIRECT ERGONOMICS IS AN INDIGENOUS BUSINESS ESTABLISHED 1986, MANUFACTURING AND SUPPLYING COMMERCIAL AND ERGONOMIC OFFICE FURNITURE TO GOVERNMENT AND CORPORATE ORGANISATIONS.

WE HAVE AN EXTENSIVE RANGE OF SIT-TO-STAND AND STATIC WORKSTATIONS, PORTABLE SIT-TO-STAND DESK UNITS, A LONG LIST OF ERGONOMIC TASK, EXECUTIVE AND VISITOR SEATING, AND CREATIVE COLLABORATIVE SEATING. ULTIMATELY THIS MAKES DIRECT ERGONOMICS A ONE-STOP SHOP FOR YOUR OFFICE FIT-OUTS AND ACTIVE WORKSPACE CREATION.

WE ARE ABLE TO SUPPLY UNDER SEVERAL GOVERNMENT CONTRACTS INCLUDING DEPARTMENT OF DEFENCE, NSW STATE GOVERNMENT OFFICE FURNITURE CONTRACT 771.

DIRECT ERGONOMICS IS A TEIR ONE SUPPLIER TO THE NSW STATE GOVERNMENT CONTRACT 771 FOR ALL CATEGORIES UNDER THE OFFICE FURNITURE SECTION (PRETTY MUCH OUR ENTIRE RANGE IS AVAILABLE UNDER THIS NEW CONTRACT)



# WHY CHOOSE DIRECT ERGONOMICS?

We are the first chosen for schoolyard footy, we are the class valedictorian and homecoming queen, we have the experience and the knowledge to get you the best product and service on the market, and we'll do it cheaper too! Need another reason? Here's three.

## 01

We LOVE Australian-made products. The majority of our furniture is made in Australia. We also have our ISO9001 certification for Standards in Quality Assurance, and AFRDI Certification on our range of ergonomic seating, visitor and executive seating, and workstations. So you can rest easy knowing that you're getting the best quality product we can find.



## 02

We have our ISO14001 certification for Standards in Environmental Management, and over half of our range is GECA certified! We were one of the first in our industry to use water-based non-toxic glues, and we offer recycling options to all our customers, ensuring maximum points on the Green Building Council Matrix.

## 03

We are a small, Indigenous, family owned business. Whenever possible, we aim to support other Indigenous and Regional businesses throughout our entire production process.

## Australian-Made First.

It's not always possible, but when we can, we will always give preference to locally produced, Australian-made furniture, from Australian-owned factories and companies.

We believe in strengthening the local economy by using local installers and manufacturers, and using small businesses wherever possible.



## Coast-to-Coast Delivery and Installation.

No matter where in Australia you're based, we'll deliver to you. Our network of installers cover the entire continent, ensuring there'll always be someone there to make sure your space is set up exactly how you want it.

We'll also take all our rubbish with us, so you can relax in your new, clean office.

## Supporting Local Communities

We are proud of our Indigenous Heritage, and want to give back to disadvantaged communities in the Moree region, where our Gamilaraay / Kamilaroi forbears lived for generations pre-colonisation.

We give preference to installation and manufacturing companies owned and run by Indigenous-Australians, and a portion of our profits from selected products are given to programs assisting Indigenous communities in rural NSW.

# Our Services

## Project Planning and Design.

Need a hand? Direct Ergonomics offers space and project planning to help design your new office area. We'll help measure your space and make sure there's enough room and equipment for everyone to work comfortably and within compliance standards.

We'll incorporate your advice on filing and storage, WH&S and individual requirements to ensure that the end result is a fully functioning area that adds to the wellbeing of the organisation - for a better working environment. We can assist with your product specifications, produce prospectus and shop drawings, and consult on style and colour.

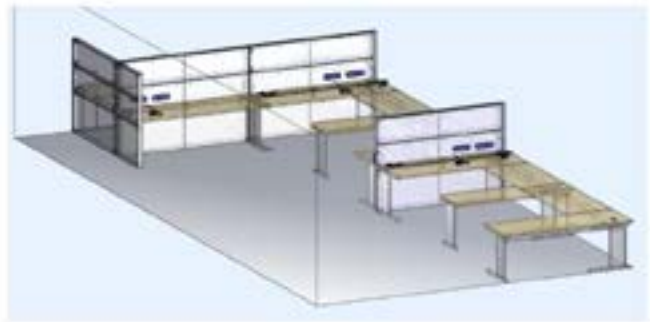

## Stand Out from the Crowd.

Can't find what you had in mind? Need items of a specific size, colour, finish, or fabric? Our wide range of suppliers, in addition to in-house production, means there's no design that can't be manufactured. Let us know how we can help you create the space you need. We'll source the best materials from our reliable suppliers, so you get exactly what you want at the best possible price.

## Need it Quick?

Some items are available for quick ship, which means they are generally held in stock, and able to ship straight away.



## Not a Hoarder?

We know you'll love your new products, but how will you get rid of the old ones? Let us take care of that with our recycle service. When we deliver your shiny new furniture, we can take the old stuff with us, so you can come back to a clean, junk-free office.

\*Recycle service pricing depends on location and availability,



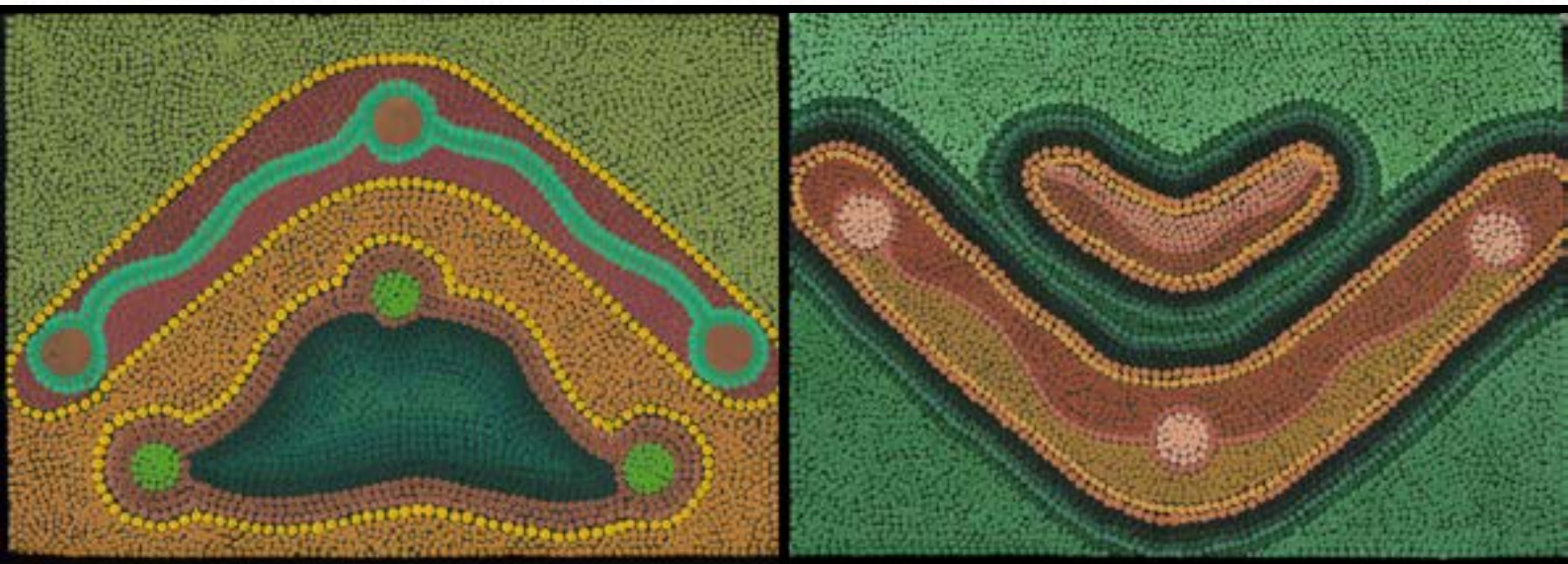

Artwork by David (Crockett) Cragie, mentor and artist for Moree TAFE. Tour guide and advisor for the Mehi Gallery and Studio. David is a Kamilaroi Man and Moree Local.

## Direct Ergonomics' Indigenous Heritage and Commitment

Direct Ergonomics is a family owned company, owned and run by Donna McMullen. Direct Ergonomics was started back in 1986 by the McMullen Family - Alan and Brett. Donna became heavily involved within the first 3 months of its operation and has been hands on ever since.

14 years ago, it became known that the McMullen Family has Indigenous Heritage. This heritage was stolen from us and the secret died with the passing of Donna's Grandmother, Dorothy McMullen (nee Taylor). Alans' Great Great Grandmother was a Gamilaraay/Kamilaroi woman named Mary Madden. This ancestry was clouded by Alans' Grandmother and her family, being brought to light over the last two decades of diligent peeling back of the layers of concealment. We are enjoying meeting relatives we never knew we had and enjoying being part of our Mob in Moree.

Today, Donna and Direct Ergonomics embrace this heritage. We aim to maintain diversity in our staffing across the entire company and endeavour to work with Indigenous suppliers and customers at every opportunity, including installation and delivery teams all over Australia.

We run several Indigenous Programs in an effort to 'give back' to our community.

**Program One:** Indigenous Cadetship Program that is aimed at helping Indigenous youth become job ready. It is a paid position running 8-12 weeks that aims to prepare the cadets with a solid work ethic and exposure to an office environment. Mentoring, assisting in resume preparation, and career guidance are all part of the program.

**Program Two:** Our Stand UP Program ensures \$10 of the purchase price of all the products in the StandUP Range goes to Youth Programs in Rural Australia. We have raised over \$20,000 and with your help we are aiming to double it.

**Program Three:** Boots N All is a new Program aimed at school children and getting them onboard to help out their fellow sportsmen in the bush. We rally around to get 'slightly used' boots and shoes and then send them on to Indigenous Communities that don't have access to new boots every season.

# Summary of — Australian Standards

## Summary of Australian Standards 4442: 2018

Quick reference guide to new Aust Standards for Office Desks and Workstations.

### Clause 2.3.2 – Office Desk Standards – Sit to Stand Workstations

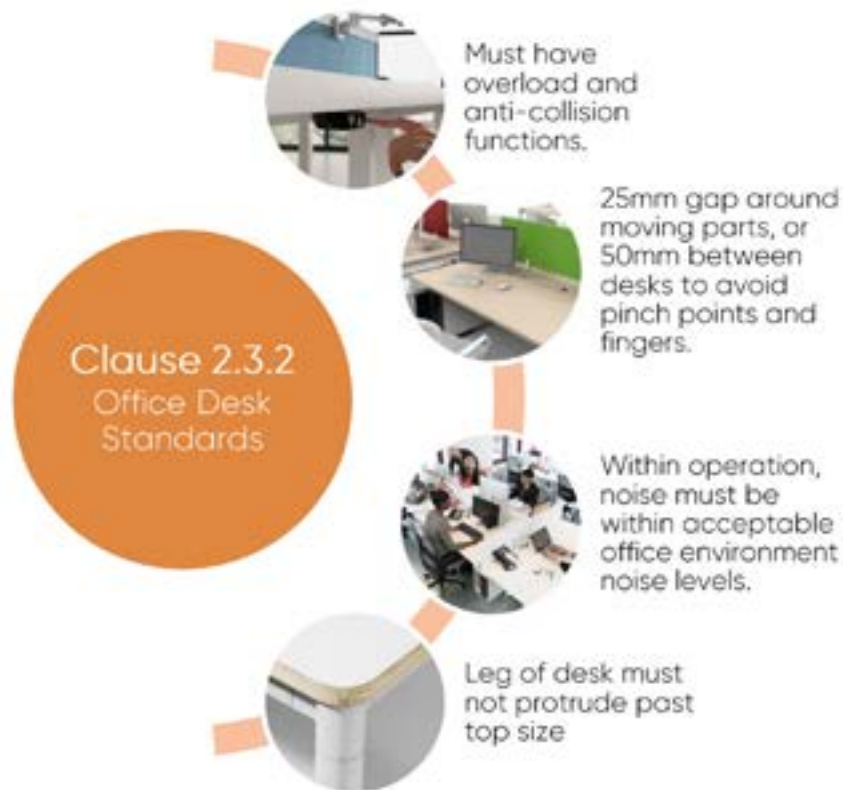

### Clause Summary – Standard Sizes for Office Desks and Workstations

Single Task: 1200 x 750

Multi-Task: 1600 x 750

### Clause 3.6.6 – Summary of Primary Worktop Heights

| Function        | Worktop Height Range (mm) |                   |
|-----------------|---------------------------|-------------------|
|                 | Fixed                     | Height Adjustable |
| Sitting Height  | 710-770                   | 620-845           |
| Standing Height | N/A                       | 975-1220          |
| Sit to Stand    | N/A                       | 620-1220          |

# STANDARD LAMINATE RANGE

## EXPRESS OPTIONS

14 Days



White200

## STANDARD OPTIONS

14-30 Days

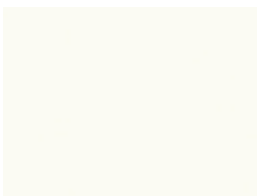

White200

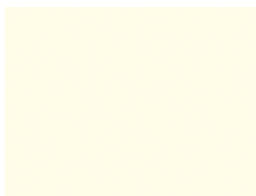

Parchment

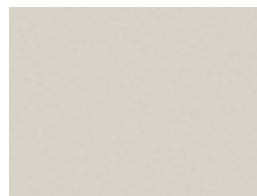

Oyster Grey

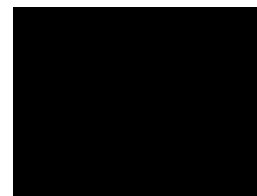

Black



Ironstone



Select Beech



Young Beech



Curly Birch



Milkwood



Seasoned Oak



Alaskan



Oyster Linea



Natural Walnut



Milano Walnut



New Graphite

This range has been carefully selected in conjunction with Laminex to provide a comprehensive range of furniture colours that are readily available to ensure your project deadlines can be met. White generally in stock in popular sizes and items.

**Note: Any other Melamine colours can be priced on application.**

### Global GreenTagCert™ Certified Products

Just like you, we care deeply about Australia's natural environment, and we strongly believe in the importance of supporting sustainable building practices, creating an extensive range of environmentally-preferred products and reducing our overall environmental impact. For this reason, we put 'Green First' and employ a range of processes, along with the latest technology to ensure we reduce our carbon footprint. But how are we actually doing this? Here are just a few examples

#### Timber Certifications

As a large manufacturer of wood products, we respect and support responsible forest management and are committed to producing quality products that are backed by globally recognised certifications.

### Global GreenTagCert™ Certified Products

Laminex Australia is proud to offer a leading range of Global GreenTagCert™ independently certified products. This certification represents the benchmark for sustainability credentials, being a globally respected environmental certification system.

### Low Emission Products

Laminex Australia recognises the benefits low emission products present in sustainable building projects. All of our Australian made Medium Density Fibreboard (MDF), has extremely low formaldehyde E0 rating.

### ISO 14001 Certification

Laminex Australia also maintains ISO 14001 Environmental Management System certification for all manufacturing sites and is progressively embarking on a number of waste and emission reduction initiatives to reduce our overall environmental impact.

### Green Building Council Membership

Laminex Australia is member of the Green Building Council of Australia, with GBCA accredited professionals.

**Laminex**



# STANDARD PARTITION FABRIC RANGE

## POWDERCOAT OPTIONS



White



Black

## SPRING FABRIC



Plum



Tomato Red



Steel Blue



Slate Grey



Sky Blue



Ruby Red



Royal Blue



Navy



Lime Green



Fern Green



Camel



Burnt Orange



Bright Orange



Black



Baby Blue



Alloy Grey

## ECHO PANEL



Bannana



Yellow

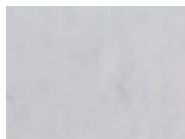

White



Slate Grey



Sky Blue



Royal Pink



Red



Purple



Pink



Peacock



Pacific Blue



Orange



Natural



Maroon



Marble



Light Beige



Grey



Green



Dark



Dark Green



Dark Blue

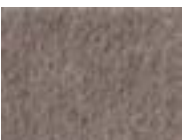

Dark Beige



Charcoal



Brown



Blue

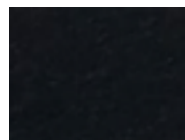

Black



# STANDARD FABRIC RANGE

EXPRESS RANGE

Ex stock



Ebony

EXTENDED RANGE

20-25 Days



Ebony



Slate



Anthracite



Graphite



Lead



Zinc



Frost

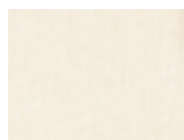

Ivory



Linen



Almond



Pumice



Pebble



Navy



Atlantic



Paprika



Pumpkin



Cherry



Marigold



Wasabi

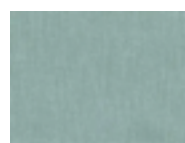

Sky

# Standard Dispatch Times

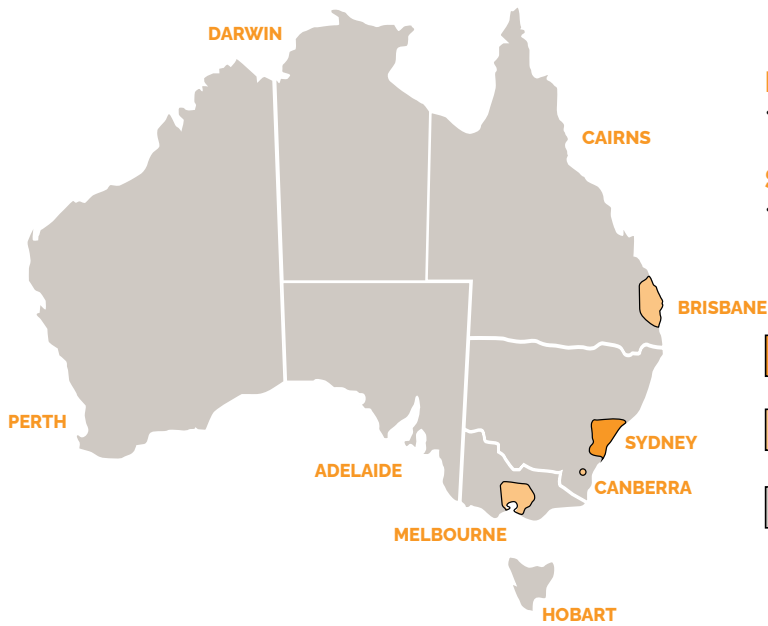

## Express Items - usual transit time

- Dispatch next day if ordered before 11.00am

## Standard product - usual transit time

- Small to large order dispatch 7-37 days from order

 3 Working days from dispatch of order

 3-5 Working days from dispatch of order

 7-21 Working days from dispatch of order

# RECEIVING DELIVERIES

## CHECK

- Thoroughly check all deliveries to confirm it has arrived undamaged.
- If there is signs of damage you can still receive the freight, but you must note the damage on the consignment note.
- Although drivers are keen to deliver the freight and depart, you have every right to ask them to wait. Drivers can be asked to wait up to 20 minutes until the receiver has completely checked the consignment.

## ENDORSE

- If an item is damaged, note the damage (endorse) on the consignment note BEFORE before signing it.
- If the packaging is damaged and you are unsure whether the item is damaged or not, endorse the consignment note as 'damaged packaging': This will help with claim should the item be damaged.

- If any items are missing, note this on the consignment note with the correct quantity before signing it.
- DE, understands larger orders can be difficult to check thoroughly at time of delivery. For orders over \$10,000 we will allow 24 hours from time of delivery for you to check the goods and inform us of anything untoward.

## ADVISE

- If your order has arrived damaged, or been short-shipped, please contact the DE Customer Care team immediately.
- Provided the consignment/Job Number note is endorsed, DE will arrange replacement parts to be dispatched expeditiously, usually within 24 hours.
- If the consignment note/ Job Number is not endorsed, DE will supply the required replacement parts at your cost, and will ensure these are dispatched ASAP, usually within 24 hours.

# RETURNS

- See <https://www.directergo.com.au/terms-and-conditions/> for Returns Policy

# PRICING

- Standard Item Pricing featured in Catalogue excludes Delivery Costing & Installation Pricing. Be sure to ask our sales team for your special pricing structure. Discounts usually apply.
- Residential Address will incur a surcharge
- All prices exclude GST.

**This price guide was updated March 23rd**

We reserve the right to update or change the pricing in this price guide at any time.



**Please note: Most product shown in this Price Guide requires onsite assembly.**

# Channels to Market

## Standard In-Stock



**"An in stock solution for every space in today's workspaces."**

### Key Advantages

- Next day dispatch
- All product made from computer controlled cutting programs to ensure perfect future product matching
- Australia wide delivery network
- Available online

## Custom In-Stock



**"A customisable offering that utilises proven, pre-engineered components and the latest design trends."**

### Key Advantages

- Fast turnaround for colour-only changes
- Can combine with install and extra services
- Leverage's off deep stock holding
- Australia wide delivery

## Bulk Buying



**"A product selection for anyone looking to utilise bulk buying to maximise profits."**

### Key Advantages

- Best price offering
- Colour/size customisable
- Backup matching stock from in-stock programmes
- Delivery windows from 8-10 weeks
- Low volume order possibilities
- Direct to site delivery programme

## Tailored Design



**"A bespoke product design/engineering/supply/deliver service that brings cost effective furniture deliverables for the hospitality, education, office and government institution sectors"**

### Key Advantages

- 40 years importing experience
- Best price for bulk made to order projects
- Colour/size customisable
- Unprecedented mixture of available materials that can be combined on the same projects, while utilising trusted, pre-proven manufacturing facilities
- ISO 9001, ISO 14001 & GECA factories
- Experienced team with delivery experience across 40 year's



# Workstations

---

Configurations for  
Every Workspace





# Workzone Desking



|                                    |       |
|------------------------------------|-------|
| Specification                      | 18-19 |
| Fixed Height                       | 20    |
| Winding Height Adjustable          | 21    |
| Electric Height Adjustable 2 Colum | 22    |
| Electric Height Adjustable 3 Colum | 23    |
| Pneumatic Height Adjustable        | 24    |
| Workzone Electric 360              | 24    |

# WORKZONE

## Product Specifications

| FRAMES                                                    | WORKTOPS                                                      | FEATURES                                                                                                       |
|-----------------------------------------------------------|---------------------------------------------------------------|----------------------------------------------------------------------------------------------------------------|
| 70 x 70mm Legs                                            | Melamine - 25mm E0 Grade Substrate, Made In Australia         | Handset - Set Restricted Height Range                                                                          |
| Flat Foot Design - Single Desk                            | Optional Scallop Cut-Out, Rear Centre of Worktop              | Handset - Digital Readout                                                                                      |
| H Frame Design - Double Sided Design                      | Two Piece top with Joiner may be used, on some 90 Degree Tops | Handset - Programmable Height Buttons                                                                          |
| Available in Fixed, Winder, Electric 2 Column or 3 Column | 90 & 120 Degree worktops include cable access hole            | Handset - Digital Readout                                                                                      |
| White or Black Powdercoat Finish                          |                                                               | Winding - Height Range 675-1115mm                                                                              |
| Weight Rating 180 kg                                      |                                                               | Electric 2C - Height Range 685-1125mm                                                                          |
|                                                           |                                                               | <b>Electric 3C - Height Range 620-1220mm, Compliant to New Australian Standards for Workstations 4442:2018</b> |

### STRAIGHT FRAMES

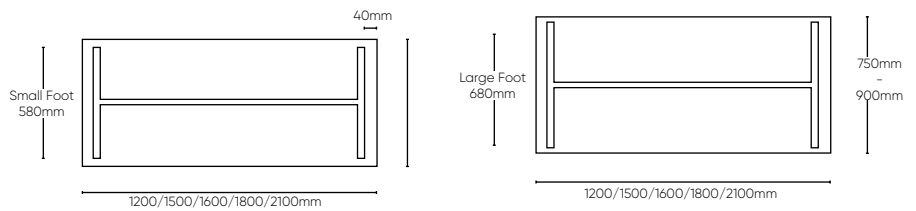

### B2B FRAMES

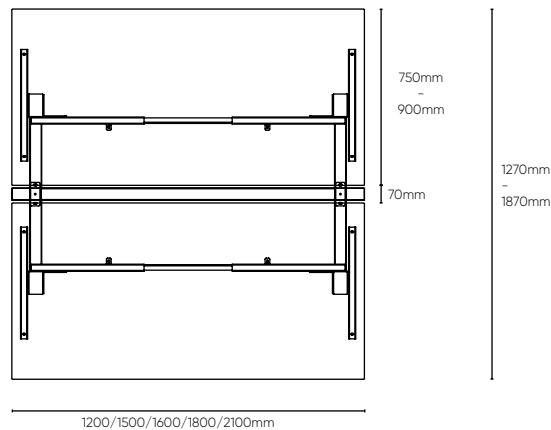

**Workstation 90° - 2C**

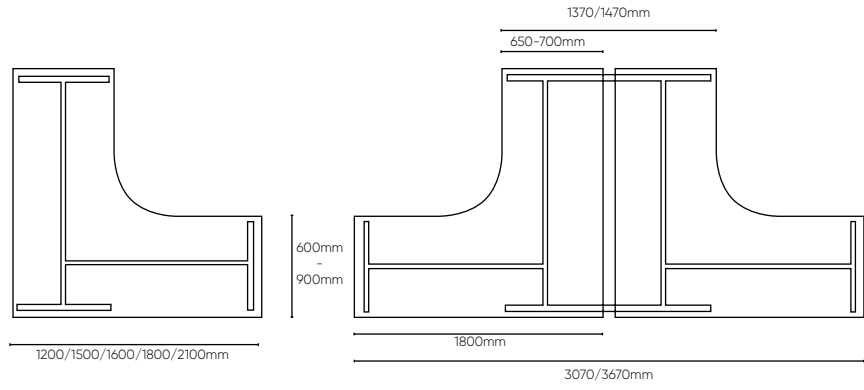

**Workstation 90° / 1208 - 3C**

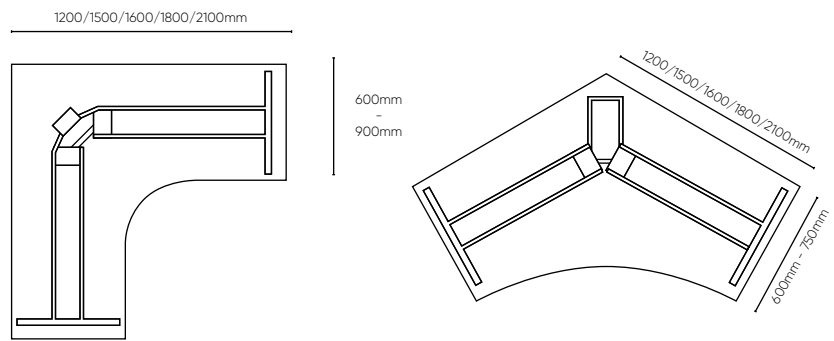

**Desk/Workstation Frame Heights (Excludes Worktop)**

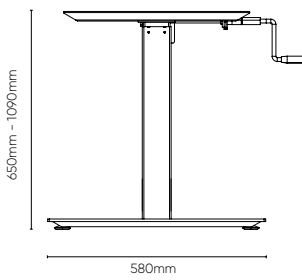

Winder Adjust  
(Speed 5 mm/Turn)

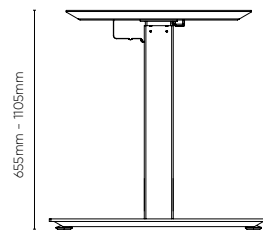

2 Column Electric Adjust  
Single Motor  
(Speed 22 mm/Sec)

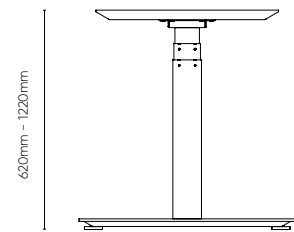

3 Column Electric Adjust  
Motor Per Leg  
(Desk & Workstation)  
(Speed 30 mm/Sec)

# WORKSTATIONS

## WORKZONE CARGO

Fixed Height Desk (720mmH)



Workzone Cargo T-legs are stylish and strong. The T-leg design enables maximum legroom especially when they are used in a linear-style layout.

Workstations are manufactured in Sydney and GECA certified. We can customise the Cargo design to suit most applications.

Workzone Cargo fixed height collection is popular for offices looking to complement their height adjustable systems with low cost benching. Fully interchangeable with the Workzone Height adjustable Range systems to enable matching aesthetics across the office.

If you are looking for freestanding or screen-based, the Cargo option will accommodate your needs.

| PRODUCT                       | WORKTOP                                                                                                                                                      |
|-------------------------------|--------------------------------------------------------------------------------------------------------------------------------------------------------------|
| <b>SINGLE SIDED DESK</b>      | 1200W x 600D<br>1200W x 750D<br>1500W x 750D<br>1500W x 800D<br>1800W x 600D<br>1800W x 750D<br>1800W x 800D<br>2100W x 600D<br>2100W x 750D<br>2100W x 800D |
| <b>B2B DESK</b>               | 2@ 1200W x 750D<br>2@ 1500W x 750D<br>2@ 1800W x 750D                                                                                                        |
| <b>CORNER 90* WORKSTATION</b> | 1500/1500W x 750D<br>1500/1800W x 750D<br>1800/1800W x 750D<br>2100/1800W x 750D<br>2100/2100W x 750D<br>2400/1800W x 750D                                   |



\* Prices Based Off White, Standard Melamine Colour Range on Page 12, surcharge & Manufacturing time will apply





# WORKSTATIONS

## WORKZONE MANUAL Winding Height Adjustable Desk (720mmH)



Workzone User Height Adjustable L Shaped Desk with Height Range 620mm – 1150mm. An ergonomically designed, versatile desking system that's perfect for the office – today and tomorrow! The Workzone Manual Desking system is built for comfort, performance and choice. Backed by our commitment to quality and product warranties, Workzone Manual brings the freedom of knowing that the office furniture is as agile as a business needs to be.

Operator can simply wind the handle clock wise to increase height and anti clock wise to decrease the height of the table top. Standard finish white powder coated frame with 25mm thick laminate top and matching ABS edging.

| PRODUCT                       | WORKTOP<br>WIDTH X DEPTH                                                                                                                                                     |
|-------------------------------|------------------------------------------------------------------------------------------------------------------------------------------------------------------------------|
| <b>Single Sided Desk</b>      | 1200W x 750D<br>1200W x 800D<br>1500W x 750D<br>1500W x 800D<br>1500W x 900D<br>1600W x 750D<br>1800W x 750D<br>1800W x 800D<br>1800W x 900D<br>2100W x 750D<br>2100W x 900D |
| <b>B2B DESK</b>               | 2@ 1500W x 750D<br>2@ 1800W x 750D                                                                                                                                           |
| <b>CORNER 90° WORKSTATION</b> | 1500/1500W x 750D<br>1500/1800W x 750D<br>1800/1800W x 750D<br>2100/1800W x 750D<br>2100/1800W x 800D<br>2100/2100W x 750D                                                   |



\* Prices Based Off White, Standard Melamine Colour Range on Page 12, surcharge & Manufacturing time will apply



# WORKSTATIONS

**WORKZONE ELECTRIC 2C**  
 Electric Height Adjustable Desk (680-1130mmH)  
 Budget Freindly, BIFMA Approved



Workzone Electric 2 Column User Height Adjustable Desk with Height Range 620mm – 1150mm. An ergonomically designed, versatile desking system that's perfect for the office – today and tomorrow! The Workzone Manual Desking system is built for comfort, performance and choice. Backed by our commitment to quality and product warranties, Workzone Manual brings the freedom of knowing that the office furniture is as agile as a business needs to be.

Operator can simply wind the handle clock wise to increase height and anti clock wise to decrease the height of the table top. Standard finish white powder coated frame with 25mm thick laminate top and matching ABS edging.

| PRODUCT                                                                             | WORKTOP                                                                                                                                                                      |
|-------------------------------------------------------------------------------------|------------------------------------------------------------------------------------------------------------------------------------------------------------------------------|
| <b>Single Sided Desk</b>                                                            | 1200W x 600D<br>1200W x 750D<br>1500W x 750D<br>1500W x 800D<br>1500W x 900D<br>1600W x 600D<br>1600W x 800D<br>1800W x 750D<br>1800W x 900D<br>2100W x 750D<br>2100W x 900D |
|   |                                                                                                                                                                              |
| <b>B2B DESK</b>                                                                     | 2@ 1200W x 750D<br>2@ 1500W x 750D<br>2@ 1800W x 750D                                                                                                                        |
|  |                                                                                                                                                                              |
| <b>CORNER 90* WORKSTATION</b>                                                       | 1800/1200W x 750D<br>1500/1800W x 750D<br>1800/1800W x 750D<br>2100/1800W x 750D<br>2100/1800W x 750D                                                                        |
|  |                                                                                                                                                                              |



\* Prices Based Off White, Standard Melamine Colour Range on Page 12, surcharge & Manufacturing time will apply



# WORKSTATIONS

## WORKZONE ELECTRIC 3C

Electric Height Adjustable Desk (620-1220mm)  
Australian Standard compliant 4442:2018



Workzone Electric 3 Column User Height Adjustable Desk is Industry leading, being one of the only Height adjustable desk on the Market that is AUS Compliant with its Height Range of 620mm – 1220mm.

An ergonomically designed, versatile desking system that's perfect for the office – today and tomorrow! The Electric 3C Desking system is built for comfort, performance and choice. Backed by our commitment to quality and product warranties, 3C brings the freedom of knowing your Desk wont damage itself by having a Anti Collision Feature built in standard, no more grinding motors by something obstructing its path.

| PRODUCT                       | WORKTOP<br>WIDTH X DEPTH                                                                                                                                                     |
|-------------------------------|------------------------------------------------------------------------------------------------------------------------------------------------------------------------------|
| <b>SINGLE SIDED DESK</b>      | 1200W x 600D<br>1200W x 750D<br>1500W x 750D<br>1500W x 800D<br>1500W x 900D<br>1600W x 750D<br>1600W x 800D<br>1800W x 750D<br>1800W x 900D<br>2100W x 750D<br>2100W x 900D |
| <b>B2B DESK</b>               | 2@ 1500W x 750D<br>2@ 1800W x 750D                                                                                                                                           |
| <b>CORNER 90* WORKSTATION</b> | 1500/1500W x 750D<br>1800/1500W x 750D<br>1800/1800W x 750D<br>2100/1800W x 750D<br>2100/2100W x 750D                                                                        |



\* Prices Based Off White, Standard Melamine Colour Range on Page 12, surcharge & Manufacturing time will apply



# WORKSTATIONS

## WORKZONE PNEUMATIC No Power Height Adjustable Desk (700-1130mm)



Taking height adjustable desks to the next level

The Workzone Pneumatic height adjustable desk has a unique patented lift design that does not require any electric power or manual crank handle. Simply press the lift handle and quickly raise or lower the desk to your desired sit/stand height. No power point – not a problem now you can locate your desk wherever you want in the room and as many as you require. Ideal for classrooms, workstations or personal office.

- Stylish and efficient, safe and versatile
- Unique patented lift mechanism
- No messy cables or power point required
- No slow crank handles or electric motors
- Height adjustable from 700mm – 1130mm

| PRODUCT                                                                            | WORKTOP<br>WIDTH X DEPTH |
|------------------------------------------------------------------------------------|--------------------------|
|  | 1200W x 700D             |
|                                                                                    | 1200W x 750D             |
|                                                                                    | 1500W x 700D             |
|                                                                                    | 1500W x 750D             |
|                                                                                    | 1500W x 900D             |
|                                                                                    | 1600W x 750D             |
|                                                                                    | 1800W x 700D             |
|                                                                                    | 1800W x 750D             |
|                                                                                    | 1800W x 900D             |
|                                                                                    | 2100W x 750D             |
|                                                                                    | 2100W x 900D             |



## WORKZONE ELECTRIC 360 Electric Height Adjustable Desk (620-1220mm) Compliant to AUS Standard 4442:2018



Go full circle with Workzone 360 desk systems. Offering ultimate versatility and choice for the modern workplace.

Quiet and seamless, the Danish design will transform the way you work. Incorporating the world's leading accentuator technology, Workzone 360 features a brand-new round leg design, offering timeless elegance to your workplace

Standard finish white powder coated frame with 25mm thick laminate top and matching ABS edging.

\* Prices Based Off White, Standard Melamine Colour Range on Page 12, surcharge & Manufacturing time will apply





# NuBloc

## DESKING



|                     |    |
|---------------------|----|
| Specifications      | 27 |
| Single Workstations | 28 |
| Desk & Returns      | 29 |
| Shared Workstation  | 30 |



# NuBloc

## PRODUCT SPECIFICATIONS

| FRAMES                                    | WORKTOPS                                                         | FEATURES                                                    |
|-------------------------------------------|------------------------------------------------------------------|-------------------------------------------------------------|
| 50 x 50 mm Square Leg<br>50 x 25 mm rails | Melamine - 25mm Eo Grade Substrate,<br>Made In Australia         | Fully Recycled Aluminium                                    |
| 80 mm height adjustment in each foot      | Optional Scallop Cut-Out,<br>Rear Centre of Worktop              | Repeating leg patterns                                      |
| White or Black Powdercoat finish          | Two Piece top with Joiner may be used,<br>on some 90 Degree Tops | Linear Double or Back to Back<br>workstation configurations |
| Multiple rail positions on each frame     | 90 & 120 Degree worktops include cable<br>access hole            | Conference Table Configurations                             |
| Worktop height 715 mm                     |                                                                  | Multi Leg Conference Table Configurations                   |
|                                           |                                                                  | Corner Workstation Configurations                           |

### STRAIGHT FRAMES

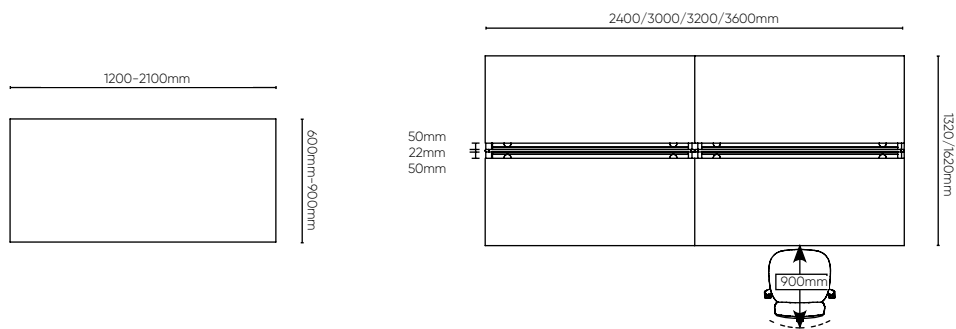

### 90° FRAMES

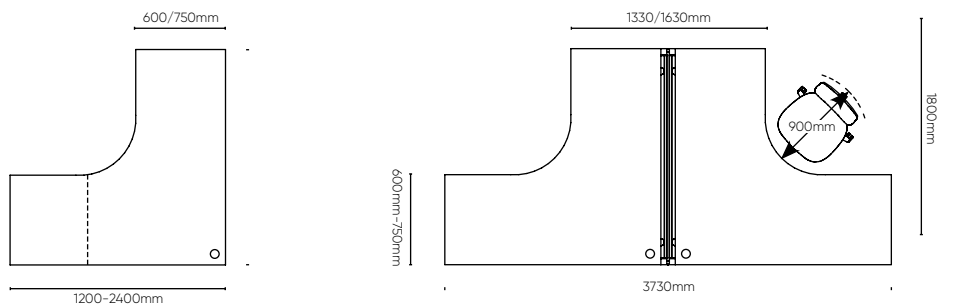

### 120° FRAMES

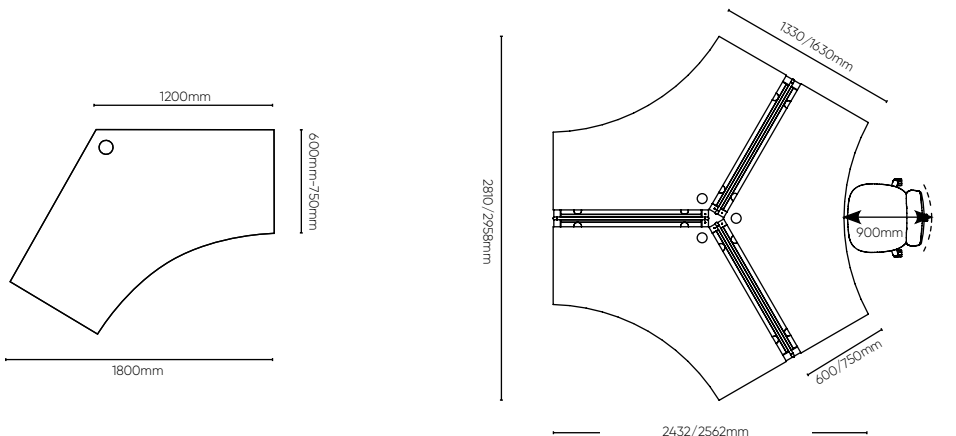

## NUBLOC SINGLE

Fixed Height Desk (715mmH)





The NuBloc leg features a timeless classic square leg that will fit into any office or waiting room space. Highly versatile, this simple desk is available in a wide range of shapes, sizes, and height options, so you will always find one that suits your space.

The NuBloc is constructed with fully recyclable aluminium which can be finished with GECA approved EO Worksurfaces to help your clients receive maximum points towards Green Star building accreditation.

Features of the NuBloc:

- Recyclable Components – Ask us about our Stewardship Programme
- Linear Single Configurations are possible by repeating leg frames
- Linear Double or Back to Back Workstation configurations are possible
- Conference Table Configurations are possible with these Leg frames
- Multi Leg Conference Tables are possible by repeating Leg frames
- Corner Workstation configurations are possible
- Standard Finish is White Frame with choice of Laminate Top

| PRODUCT                                                                                                              | WORKTOP<br>WIDTH X DEPTH |
|----------------------------------------------------------------------------------------------------------------------|--------------------------|
| <b>Single Sided Desk</b><br>      | 800W x 750D              |
|                                                                                                                      | 1200W x 600D             |
|                                                                                                                      | 1200W x 750D             |
|                                                                                                                      | 1250W x 900D             |
|                                                                                                                      | 1300W x 900D             |
|                                                                                                                      | 1500W x 750D             |
|                                                                                                                      | 1500W x 900D             |
|                                                                                                                      | 1600W x 800D             |
|                                                                                                                      | 1800W x 750D             |
|                                                                                                                      | 1800W x 900D             |
|                                                                                                                      | 2000W x 900D             |
|                                                                                                                      | 2100W x 750D             |
| 2100W x 900D                                                                                                         |                          |
| <b>Corner 90° Workstation</b><br> | 1500/1500W x 750D        |
|                                                                                                                      | 1500/1800W x 750D        |
|                                                                                                                      | 1800/1800W x 750D        |
|                                                                                                                      | 2100/1800W x 750D        |
|                                                                                                                      | 2400/1800W x 750D        |
|                                                                                                                      | 2400/2100W x 750D        |
|                                                                                                                      |                          |



\* Prices Based Off White, Standard Melamine Colour Range on Page 12, surcharge & Manufacturing time will apply



# WORKSTATIONS

## NUBLOC DESK & RETURN

Fixed Height Desk (715mmH)



| PRODUCT                                                                                                                                                                    | DESCRIPTION                                                                                                                                              | WORKTOP<br>WIDTH X DEPTH      |
|----------------------------------------------------------------------------------------------------------------------------------------------------------------------------|----------------------------------------------------------------------------------------------------------------------------------------------------------|-------------------------------|
|                                                                                           | <b>Corner<br/>120°<br/>Workstation</b>                                                                                                                   | 1200/1200W x 600D             |
|                                                                                                                                                                            |                                                                                                                                                          | 1200/1200W x 750D             |
| <br> | <b>Desk with Left or<br/>Right Return</b><br><br>When ordering select<br>Right Hand (RH) or<br>Left Hand (LH) Return                                     | 1800W x 600D/<br>900W x 600D  |
|                                                                                                                                                                            |                                                                                                                                                          | 1800W x 750D/<br>900W x 600D  |
|                                                                                                                                                                            |                                                                                                                                                          | 1800W x 900D/<br>900W x 600D  |
|                                                                                                                                                                            |                                                                                                                                                          | 1800W x 600D/<br>1200W x 600D |
|                                                                                                                                                                            |                                                                                                                                                          | 1800W x 750D/<br>1200W x 600D |
|                                                                                                                                                                            |                                                                                                                                                          | 1800W x 900D/<br>1200W x 600D |
|                                                                                                                                                                            |                                                                                                                                                          | 1800W x 600D/<br>900W x 600D  |
| <br> | <b>Desk with Left<br/>or Right Return in-<br/>cludes Melamine<br/>Modesty</b><br><br>When ordering select<br>Right Hand (RH) or Left<br>Hand (LH) Return | 1800W x 750D/<br>900W x 600D  |
|                                                                                                                                                                            |                                                                                                                                                          | 1800W x 900D/<br>900W x 600D  |
|                                                                                                                                                                            |                                                                                                                                                          | 1800W x 600D/<br>1200W x 600D |
|                                                                                                                                                                            |                                                                                                                                                          | 1800W x 750D/<br>1200W x 600D |
|                                                                                                                                                                            |                                                                                                                                                          | 1800W x 900D/<br>1200W x 600D |



\* Prices Based Off White, Standard Melamine Colour Range on Page 12, surcharge & Manufacturing time will apply



## NUBLOC SHARED DESK

Fixed Height Desk (715mmH)



### PRODUCT

### WORKTOP WIDTH x DEPTH

#### 2 USER WORKSPACE



- 2@ 1200W x 750D
- 2@ 1500W x 750D
- 2@ 1800W x 750D

#### 3 USER WORKSPACE



- 3@ 1200W x 750D
- 3@ 1500W x 750D
- 3@ 1800W x 750D

#### 2 USER DOUBLE SIDED WORKSTATION



- 2@ 1200W x 750D
- 2@ 1500W x 600D
- 2@ 1500W x 750D
- 2@ 1800W x 600D
- 2@ 1800W x 750D



\* Prices Based Off White, Standard Melamine Colour Range on Page 12, surcharge & Manufacturing time will apply





PROVIDING PERFECTLY  
DESIGNED PRODUCTS  
THAT MATCH TODAY AND  
WELL INTO THE FUTURE.





# VISTA DESKING



|                          |    |
|--------------------------|----|
| Specifications           | 33 |
| Single Sided Workstation | 34 |
| Desk & Returns           | 34 |
| Shared Desk              | 35 |

# VISTA

## PRODUCT SPECIFICATIONS

### FRAMES

Legs Constructed with Black Powder coat top housing and Natural Finish Solid Oak

Single desks & DSD Configurations

Worktop height 720mm

25mm Adjustable Foot

70 x 50 mm Leg

### WORKTOPS

Melamine - 25mm E0 Grade Substrate, Made In Australia

Optional Scallop Cut-Out, Rear Centre of Worktop

Two Piece top with Joiner may be used, on some 90 Degree Tops

90 & 120 Degree worktops include cable access hole

### VISTA SINGLE DESK (TYPICAL FRAME DIMENSIONS)



### VISTA DESK & RETURN (TYPICAL FRAME DIMENSIONS)

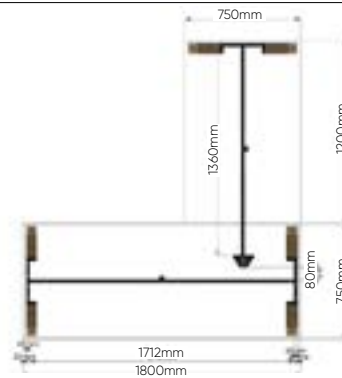

### VISTA DOUBLE SIDED DESKS (TYPICAL FRAME DIMENSIONS)

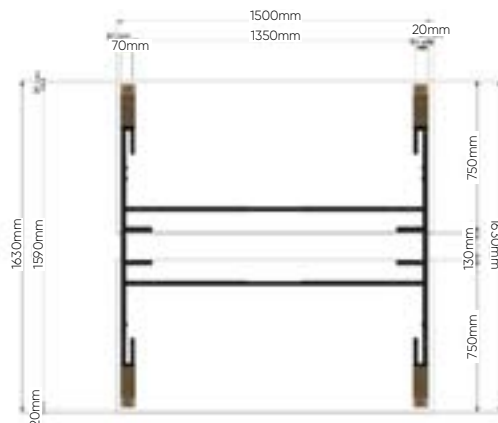

# WORKSTATIONS

## VISTA DESK Fixed Height Desk (720mmH)



| PRODUCT                                                                             | DESCRIPTION                                                                                                                                       | WORKTOP<br>WIDTH X DEPTH |
|-------------------------------------------------------------------------------------|---------------------------------------------------------------------------------------------------------------------------------------------------|--------------------------|
|    | <b>SINGLE SIDED DESK</b>                                                                                                                          | 1200W x 750D             |
|                                                                                     |                                                                                                                                                   | 1500W x 750D             |
|                                                                                     |                                                                                                                                                   | 1500W x 800D             |
|                                                                                     |                                                                                                                                                   | 1800W x 600D             |
|                                                                                     |                                                                                                                                                   | 1800W x 750D             |
|    | <b>SINGLE WORKSPACE</b><br>Includes Blade<br>E-Panel modesty<br>(1190mmW x 400mmH)                                                                | 1500W x 750D             |
|                                                                                     |                                                                                                                                                   | 1500W x 800D             |
|                                                                                     |                                                                                                                                                   | 1600W x 750D             |
|   | <b>SINGLE WORKSPACE</b><br>Includes Blade<br>E-Panel modesty<br>(1490mmW x 400mmH)                                                                | 1600W x 800D             |
|                                                                                     |                                                                                                                                                   | 1800W x 750D             |
|                                                                                     |                                                                                                                                                   | 1800W x 800D             |
|                                                                                     |                                                                                                                                                   | 1800W x 900D             |
|  | <b>DESK &amp; RETURN</b><br>Straight Splay<br>with Full Frame<br>(1200W x 750D Return)                                                            | 1500W x 750D             |
|                                                                                     |                                                                                                                                                   | 1500W x 800D             |
|                                                                                     |                                                                                                                                                   | 1600W x 750D             |
|                                                                                     |                                                                                                                                                   | 1600W x 800D             |
|                                                                                     |                                                                                                                                                   | 1800W x 750D             |
|                                                                                     |                                                                                                                                                   | 1800W x 800D             |
|  | <b>DESK &amp; RETURN</b><br>Straight Splay<br>with Full Frame<br>(1200W x 750D Return)<br>Includes Blade E-Panel<br>Modesty<br>(1190mmW x 400mmH) | 1500W x 750D             |
|                                                                                     |                                                                                                                                                   | 1500W x 800D             |
|                                                                                     |                                                                                                                                                   | 1600W x 750D             |
|                                                                                     |                                                                                                                                                   | 1600W x 800D             |
|                                                                                     |                                                                                                                                                   | 1600W x 800D             |
|  | <b>DESK &amp; RETURN</b><br>Straight Splay<br>with Full Frame<br>(1200W x 750D Return)<br>Includes Blade E-Panel<br>Modesty<br>(1490mmW x 400mmH) | 1800W x 750D             |
|                                                                                     |                                                                                                                                                   | 1800W x 800D             |
|                                                                                     |                                                                                                                                                   | 1800W x 900D             |



\* Prices Based Off White, Standard Melamine Colour Range on Page 12, surcharge & Manufacturing time will apply



# WORKSTATIONS

## VISTA SHARED DESK Fixed Height Desk (720mmH)



| PRODUCT                                                                             | DESCRIPTION                                                           | WORKTOP<br>WIDTH X DEPTH                                                            |                                                                       |                  |
|-------------------------------------------------------------------------------------|-----------------------------------------------------------------------|-------------------------------------------------------------------------------------|-----------------------------------------------------------------------|------------------|
|    | <b>2 USER<br/>DOUBLE SIDED<br/>WORKSTATION</b><br>Excludes Cable Tray | 2 @ 1200W x 600D                                                                    |                                                                       |                  |
|                                                                                     |                                                                       | 2 @ 1200W x 750D                                                                    |                                                                       |                  |
|                                                                                     |                                                                       | 2 @ 1500W x 600D                                                                    |                                                                       |                  |
|                                                                                     |                                                                       | 2 @ 1500W x 750D                                                                    |                                                                       |                  |
|                                                                                     |                                                                       | 2 @ 1500W x 800D                                                                    |                                                                       |                  |
|                                                                                     |                                                                       | 2 @ 1600W x 600D                                                                    |                                                                       |                  |
|                                                                                     |                                                                       | 2 @ 1600W x 750D                                                                    |                                                                       |                  |
|                                                                                     |                                                                       | 2 @ 1600W x 800D                                                                    |                                                                       |                  |
|                                                                                     |                                                                       | 2 @ 1800W x 600D                                                                    |                                                                       |                  |
|                                                                                     |                                                                       | 2 @ 1800W x 750D                                                                    |                                                                       |                  |
|                                                                                     |                                                                       | 2 @ 1800W x 800D                                                                    |                                                                       |                  |
|                                                                                     |                                                                       |  | <b>4 USER<br/>DOUBLE SIDED<br/>WORKSTATION</b><br>Excludes Cable Tray | 4 @ 1200W x 600D |
|                                                                                     |                                                                       |                                                                                     |                                                                       | 4 @ 1200W x 750D |
| 4 @ 1500W x 600D                                                                    |                                                                       |                                                                                     |                                                                       |                  |
| 4 @ 1500W x 750D                                                                    |                                                                       |                                                                                     |                                                                       |                  |
| 4 @ 1500W x 800D                                                                    |                                                                       |                                                                                     |                                                                       |                  |
| 4 @ 1600W x 600D                                                                    |                                                                       |                                                                                     |                                                                       |                  |
| 4 @ 1600W x 750D                                                                    |                                                                       |                                                                                     |                                                                       |                  |
| 4 @ 1600W x 800D                                                                    |                                                                       |                                                                                     |                                                                       |                  |
| 4 @ 1800W x 600D                                                                    |                                                                       |                                                                                     |                                                                       |                  |
| 4 @ 1800W x 800D                                                                    |                                                                       |                                                                                     |                                                                       |                  |
|  | <b>6 USER<br/>DOUBLE SIDED<br/>WORKSTATION</b><br>Excludes Cable Tray | 6 @ 1200W x 600D                                                                    |                                                                       |                  |
|                                                                                     |                                                                       | 6 @ 1200W x 750D                                                                    |                                                                       |                  |
|                                                                                     |                                                                       | 6 @ 1500W x 600D                                                                    |                                                                       |                  |
|                                                                                     |                                                                       | 6 @ 1500W x 750D                                                                    |                                                                       |                  |
|                                                                                     |                                                                       | 6 @ 1500W x 800D                                                                    |                                                                       |                  |
|                                                                                     |                                                                       | 6 @ 1600W x 600D                                                                    |                                                                       |                  |
|                                                                                     |                                                                       | 6 @ 1600W x 750D                                                                    |                                                                       |                  |
|                                                                                     |                                                                       | 6 @ 1600W x 800D                                                                    |                                                                       |                  |
|                                                                                     |                                                                       | 6 @ 1800W x 600D                                                                    |                                                                       |                  |
|                                                                                     |                                                                       | 6 @ 1800W x 800D                                                                    |                                                                       |                  |



\* Prices Based Off White, Standard Melamine Colour Range on Page 12, surcharge & Manufacturing time will apply



# WORKSPACES WITH A VISION





# MONICO LOOP

## DESKING



|                                   |       |
|-----------------------------------|-------|
| Specifications                    | 38    |
| Single Sided & Corner Workstation | 39    |
| Desk & Returns                    | 40    |
| Shared Desk                       | 41-42 |

# MONICO LOOP

## PRODUCT SPECIFICATIONS

| FRAMES                                               | WORKTOPS                                                      | FEATURES                                                 |
|------------------------------------------------------|---------------------------------------------------------------|----------------------------------------------------------|
| 50 x 50 x 50 mm Triangle Frame with 50 x 25 mm rails | Melamine - 25mm E0 Grade Substrate, Made In Australia         | Fully Recycled Aluminium                                 |
| 30 mm height adjustment in each foot                 | Optional Scallop Cut-Out, Rear Centre of Worktop              | Repeating leg patterns                                   |
| White or Black Powdercoat finish                     | Two Piece top with Joiner may be used, on some 90 Degree Tops | Linear Double or Back to Back workstation configurations |
| Multiple rail positions on each frame                | 90 & 120 Degree worktops include cable access hole            | Conference Table Configurations                          |
| Worktop height 715 mm                                |                                                               | Multi Leg Conference Table Configurations                |
|                                                      |                                                               | Corner Workstation Configurations                        |

### STRAIGHT FRAMES

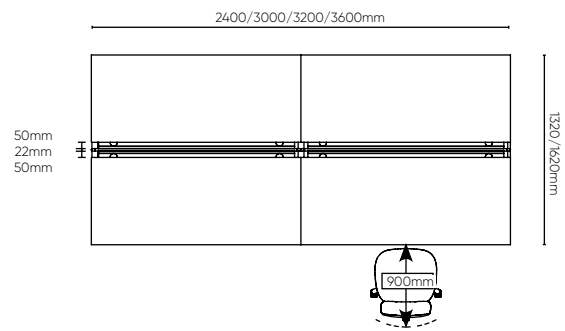
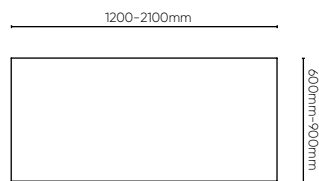

### 90° FRAMES

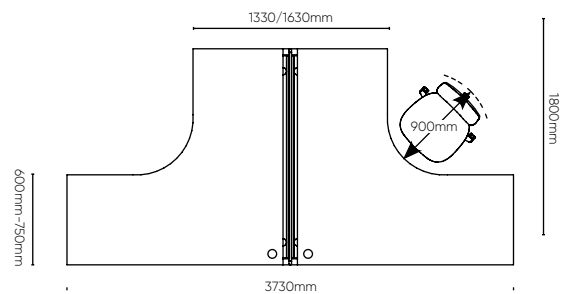
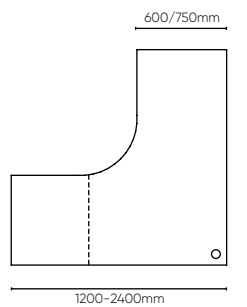

### 120° FRAMES

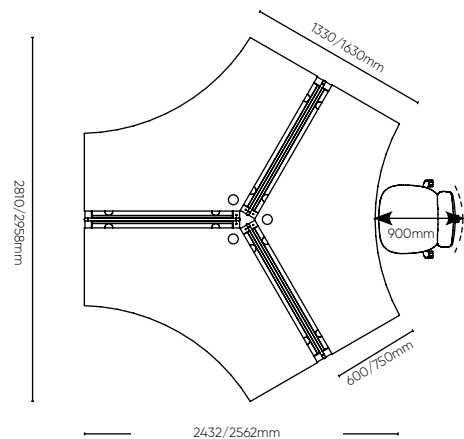
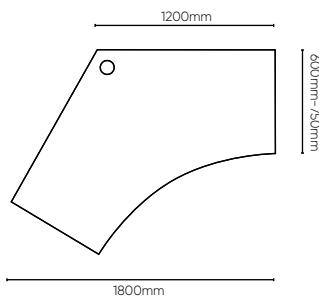

# WORKSTATIONS

## MONICO LOOP DESK Fixed Height Desk (715mmH)



| PRODUCT                                                                             | DESCRIPTION                                          | WORKTOP<br>WIDTH X DEPTH |
|-------------------------------------------------------------------------------------|------------------------------------------------------|--------------------------|
|    | <b>SINGLE SIDED DESK</b>                             | 1200W x 600D             |
|                                                                                     |                                                      | 1200W x 750D             |
|                                                                                     |                                                      | 1500W x 600D             |
|                                                                                     |                                                      | 1500W x 750D             |
|                                                                                     |                                                      | 1500W x 800D             |
|                                                                                     |                                                      | 1800W x 600D             |
|                                                                                     |                                                      | 1800W x 750D             |
|                                                                                     |                                                      | 1800W x 800D             |
|                                                                                     |                                                      | 2100W x 750D             |
|                                                                                     |                                                      | 2100W x 800D             |
|   | <b>SINGLE WORKSPACE</b><br>Includes Melamine modesty | 1500W x 600D             |
|                                                                                     |                                                      | 1500W x 750D             |
|                                                                                     |                                                      | 1800W x 600D             |
|                                                                                     |                                                      | 1800W x 750D             |
|                                                                                     |                                                      | 1800W x 900D             |
|  | <b>CORNER 90° WORKSTATION</b>                        | 1500/1500W x 750D        |
|                                                                                     |                                                      | 1500/1800W x 750D        |
|                                                                                     |                                                      | 1800/1800W x 750D        |
|                                                                                     |                                                      | 2100/1800W x 750D        |
|                                                                                     |                                                      | 2400/1800W x 750D        |
|  | <b>CORNER 120° WORKSTATION</b>                       | 1200/1200W x 600D        |
|                                                                                     |                                                      | 1200/1200W x 750D        |



\* Prices Based Off White, Standard Melamine Colour Range on Page 12, surcharge & Manufacturing time will apply



# WORKSTATIONS

## MONICO LOOP DESK & RETURN

Fixed Height Desk (715mmH)

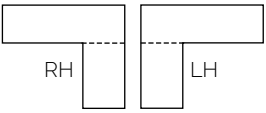
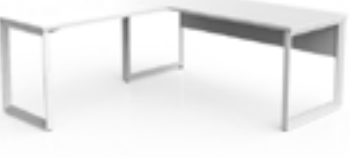
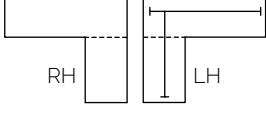

| PRODUCT                                                                                                                                                                    | DESCRIPTION                                                                                                                                 | WORKTOP WIDTH X DEPTH         |
|----------------------------------------------------------------------------------------------------------------------------------------------------------------------------|---------------------------------------------------------------------------------------------------------------------------------------------|-------------------------------|
| <br>     | <p><b>DESK WITH LEFT OR RIGHT RETURN</b></p> <p>When ordering select Right Hand (RH) or Left Hand (LH) Return</p>                           | 1800W x 600D/<br>900W x 600D  |
|                                                                                                                                                                            |                                                                                                                                             | 1800W x 750D/<br>900W x 600D  |
|                                                                                                                                                                            |                                                                                                                                             | 1800W x 900D/<br>900W x 600D  |
|                                                                                                                                                                            |                                                                                                                                             | 1800W x 600D/<br>1200W x 600D |
|                                                                                                                                                                            |                                                                                                                                             | 1800W x 750D/<br>1200W x 600D |
|                                                                                                                                                                            |                                                                                                                                             | 1800W x 900D/<br>1200W x 600D |
| <br> | <p><b>DESK WITH LEFT OR RIGHT RETURN INCLUDES MELAMINE MODESTY</b></p> <p>When ordering select Right Hand (RH) or Left Hand (LH) Return</p> | 1800W x 600D/<br>900W x 600D  |
|                                                                                                                                                                            |                                                                                                                                             | 1800W x 750D/<br>900W x 600D  |
|                                                                                                                                                                            |                                                                                                                                             | 1800W x 900D/<br>900W x 600D  |
|                                                                                                                                                                            |                                                                                                                                             | 1800W x 600D/<br>1200W x 600D |
|                                                                                                                                                                            |                                                                                                                                             | 1800W x 750D/<br>1200W x 600D |
|                                                                                                                                                                            |                                                                                                                                             | 1800W x 900D/<br>1200W x 600D |





\* Prices Based Off White, Standard Melamine Colour Range on Page 12, surcharge & Manufacturing time will apply



# WORKSTATIONS

## MONICO LOOP SHARED DESK Fixed Height Desk (715mmH)



| PRODUCT                                                                             | DESCRIPTION                                    | WORKTOP<br>WIDTH X DEPTH |
|-------------------------------------------------------------------------------------|------------------------------------------------|--------------------------|
|    | <b>2 USER<br/>WORKSPACE</b>                    | 2 @ 1200W x 600D         |
|                                                                                     |                                                | 2 @ 1200W x 750D         |
|                                                                                     |                                                | 2 @ 1500W x 600D         |
|                                                                                     |                                                | 2 @ 1500W x 750D         |
|                                                                                     |                                                | 2 @ 1500W x 800D         |
|                                                                                     |                                                | 2 @ 1600W x 600D         |
|                                                                                     |                                                | 2 @ 1600W x 750D         |
|                                                                                     |                                                | 2 @ 1800W x 600D         |
|                                                                                     |                                                | 2 @ 1800W x 750D         |
|                                                                                     |                                                | 2 @ 1800W x 800D         |
|  | <b>3 USER<br/>WORKSPACE</b>                    | 3 @ 1200W x 600D         |
|                                                                                     |                                                | 3 @ 1200W x 750D         |
|                                                                                     |                                                | 3 @ 1500W x 600D         |
|                                                                                     |                                                | 3 @ 1500W x 750D         |
|                                                                                     |                                                | 3 @ 1500W x 800D         |
|                                                                                     |                                                | 3 @ 1600W x 600D         |
|                                                                                     |                                                | 3 @ 1600W x 750D         |
|                                                                                     |                                                | 3 @ 1600W x 800D         |
|                                                                                     |                                                | 3 @ 1800W x 600D         |
|                                                                                     |                                                | 3 @ 1800W x 750D         |
| 3 @ 1800W x 800D                                                                    |                                                |                          |
|  | <b>2 USER<br/>DOUBLE SIDED<br/>WORKSTATION</b> | 2 @ 1200W x 600D         |
|                                                                                     |                                                | 2 @ 1200W x 750D         |
|                                                                                     |                                                | 2 @ 1500W x 600D         |
|                                                                                     |                                                | 2 @ 1500W x 750D         |
|                                                                                     |                                                | 2 @ 1500W x 800D         |
|                                                                                     |                                                | 2 @ 1600W x 600D         |
|                                                                                     |                                                | 2 @ 1600W x 750D         |
|                                                                                     |                                                | 2 @ 1600W x 800D         |
|                                                                                     |                                                | 2 @ 1800W x 600D         |
|                                                                                     |                                                | 2 @ 1800W x 750D         |
| 2 @ 1800W x 800D                                                                    |                                                |                          |



\* Prices Based Off White, Standard Melamine Colour Range on Page 12, surcharge & Manufacturing time will apply







# WORKSTATIONS

## MONICO LOOP SHARED DESK

Fixed Height Desk (715mmH)



| PRODUCT                                                                             | DESCRIPTION                                    | WORKTOP WIDTH X DEPTH                                                               |                                                |                  |
|-------------------------------------------------------------------------------------|------------------------------------------------|-------------------------------------------------------------------------------------|------------------------------------------------|------------------|
|    | <b>4 USER<br/>DOUBLE SIDED<br/>WORKSTATION</b> | 4 @ 1200W x 600D                                                                    |                                                |                  |
|                                                                                     |                                                | 4 @ 1200W x 750D                                                                    |                                                |                  |
|                                                                                     |                                                | 4 @ 1500W x 600D                                                                    |                                                |                  |
|                                                                                     |                                                | 4 @ 1500W x 750D                                                                    |                                                |                  |
|                                                                                     |                                                | 4 @ 1500W x 800D                                                                    |                                                |                  |
|                                                                                     |                                                | 4 @ 1600W x 600D                                                                    |                                                |                  |
|                                                                                     |                                                | 4 @ 1600W x 750D                                                                    |                                                |                  |
|                                                                                     |                                                | 4 @ 1600W x 800D                                                                    |                                                |                  |
|                                                                                     |                                                | 4 @ 1800W x 600D                                                                    |                                                |                  |
|                                                                                     |                                                | 4 @ 1800W x 750D                                                                    |                                                |                  |
|                                                                                     |                                                | 4 @ 1800W x 800D                                                                    |                                                |                  |
|                                                                                     |                                                |  | <b>6 USER<br/>DOUBLE SIDED<br/>WORKSTATION</b> | 6 @ 1200W x 600D |
|                                                                                     |                                                |                                                                                     |                                                | 6 @ 1200W x 750D |
| 6 @ 1500W x 600D                                                                    |                                                |                                                                                     |                                                |                  |
| 6 @ 1500W x 750D                                                                    |                                                |                                                                                     |                                                |                  |
| 6 @ 1500W x 800D                                                                    |                                                |                                                                                     |                                                |                  |
| 6 @ 1600W x 600D                                                                    |                                                |                                                                                     |                                                |                  |
| 6 @ 1600W x 750D                                                                    |                                                |                                                                                     |                                                |                  |
| 6 @ 1600W x 800D                                                                    |                                                |                                                                                     |                                                |                  |
| 6 @ 1800W x 600D                                                                    |                                                |                                                                                     |                                                |                  |
| 6 @ 1800W x 750D                                                                    |                                                |                                                                                     |                                                |                  |
|  | <b>2 USER 90°<br/>WORKSPACE</b>                | 1800/1800W x 600D                                                                   |                                                |                  |
|                                                                                     |                                                | 1800/1800W x 750D                                                                   |                                                |                  |



\* Prices Based Off White, Standard Melamine Colour Range on Page 12, surcharge & Manufacturing time will apply



ANY SETTING TO GATHER  
TEAMS FOR DISCUSSIONS.



# MF1 SLAB END DESKING



|                                    |    |
|------------------------------------|----|
| Specifications                     | 45 |
| Single Sided & Corner Workstations | 46 |
| Shared Desk                        | 46 |

# MF1 SLAB END

## PRODUCT SPECIFICATIONS

### FRAMES

Melamine - 18/25mm E1 Grade substrate fished in Standard Melamine Colour range with matching PVC Edge

Worktop height 715 mm

### WORKTOPS

Melamine - 25mm E0 Grade Substrate, Made In Australia

Optional Scallop Cut-Out, Rear Centre of Worktop

Two Piece top with Joiner may be used, on some 90 Degree Tops

90 Degree worktops include cable access hole

### FEATURES

Cable Holes on all single & Workstations

Fast Assembly System

Shared Desk Can use Cable Management Systems

### STRAIGHT DESK

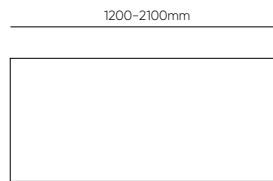

50mm  
22mm  
50mm

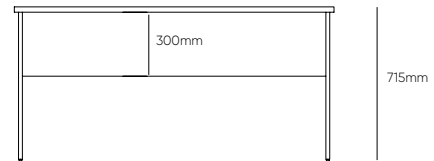

### 90° WORKSTATIONS

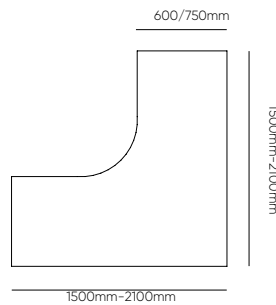

### DOUBLE SIDED DESKS

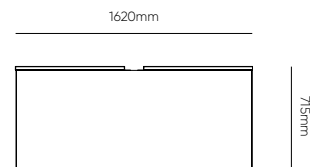
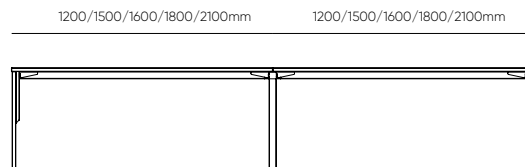





# WORKSTATIONS

## MF1 SLAB END DESK

Fixed Height Desk (715mmH)



| PRODUCT                                                                                                                       | WORKTOP WIDTH X DEPTH |
|-------------------------------------------------------------------------------------------------------------------------------|-----------------------|
| <b>SINGLE SIDED DESK</b><br>                 | 900W x 750D           |
|                                                                                                                               | 900W x 750D           |
|                                                                                                                               | 1500W x 750D          |
|                                                                                                                               | 1800W x 750D          |
|                                                                                                                               | 2100W x 750D          |
|                                                                                                                               | 2400W x 750D          |
| <b>FIXED RETURN</b><br>                      | 900W x 600D           |
|                                                                                                                               | 900W x 750D           |
|                                                                                                                               | 1200W x 600D          |
|                                                                                                                               | 1200W x 750D          |
|                                                                                                                               | 1500W x 600D          |
|                                                                                                                               | 1800W x 600D          |
| <b>CORNER 90° WORKSTATION</b><br>          | 1500/1500W x 600D     |
|                                                                                                                               | 1500/1500W x 750D     |
|                                                                                                                               | 1500/1800W x 750D     |
|                                                                                                                               | 1800/1800W x 750D     |
|                                                                                                                               | 2100/1800W x 750D     |
|                                                                                                                               | 2100/2100W x 750D     |
| <b>2 USER DOUBLE SIDED WORKSTATION</b><br> | 2 @ 1200W x 600D      |
|                                                                                                                               | 2 @ 1200W x 750D      |
|                                                                                                                               | 2 @ 1500W x 600D      |
|                                                                                                                               | 2 @ 1500W x 750D      |
|                                                                                                                               | 2 @ 1800W x 600D      |
|                                                                                                                               | 2 @ 1800W x 750D      |
| <b>4 USER DOUBLE SIDED WORKSTATION</b><br> | 4 @ 1200W x 600D      |
|                                                                                                                               | 4 @ 1200W x 750D      |
|                                                                                                                               | 4 @ 1500W x 600D      |
|                                                                                                                               | 4 @ 1500W x 750D      |
|                                                                                                                               | 4 @ 1800W x 600D      |
|                                                                                                                               | 4 @ 1800W x 750D      |



\* Prices Based Off White, Standard Melamine Colour Range on Page 12, surcharge & Manufacturing time will apply







# ERGONOMIC Accessories

---

The typical full-time employee spends about a third of their time at work. Why would you settle for spending a third of your life uncomfortable?

Direct Ergonomics offers a wide range of accessories to help improve your daily work experience. Standing up at work is not the only way to reduce discomfort, the use of monitor arms and antifatigue mats can also help alleviate pressure on your back and neck.



|                       |    |
|-----------------------|----|
| StandUp Pneumatic     | 50 |
| StandUp Electricity   | 51 |
| Anti Fatigue Products | 52 |
| Monitor Arms          | 53 |

# SIT TO STAND CONVERTERS

Sit to Stand workstations help break up long periods of inactivity and sitting by raising your desk or computer to standing height, allowing you the freedom to move around without interrupting your work.

The sit-to-stand workstations fall into two main categories - sit to stand Desks, and desktop sit-to-stand portable workstations. Portable sit-to-stand workstations are a great way to experience the benefits of a sit-to-stand desk without the high cost of a new desk.

The benefits of each are outlined below:

| <b>Sit to Stand Desks</b>                                                                             | <b>Portable Sit to Stand Workstations</b>                                                                             |
|-------------------------------------------------------------------------------------------------------|-----------------------------------------------------------------------------------------------------------------------|
| No need to re-arrange your desk or move items to a new workstation, the entire desk moves up and down | Relocating office? Portable sit to stand options are easy to set up and perfect for moving around.                    |
| Larger desk space, more room for all your belongings and documents                                    | More affordable! And ask us about trial options for your office.                                                      |
| Larger carrying capacity - never worry about weight capacity.                                         | You don't have to give up your existing desk, portable options will sit atop of any existing desk (of correct depth). |

The main benefit of a portable workstation is that you are able to convert any existing workstation into a sit-to-stand workstation. This is particularly useful for shared office spaces or dynamic workplaces where staff change roles or offices regularly.

Choosing a portable workstation can also save hundreds of dollars per unit compared to a sit-to-stand desk, making it an affordable option for small batch orders.

**Our Sit-to-Stand desks can be found in the Workstations section on pages 17-21.**

# ERGONOMIC ACCESSORIES

## STANDUP PNEUMATIC Single Handle Operation



**COMMUNITY SPIRIT!**  
**\$10 OF PURCHASE PRICE GOES DIRECTLY TO HELPING INDIGENOUS YOUTH IN RURAL AUSTRALIA.**

# STANDUP

Stand Up and Live Longer! Slimline StandUp effortlessly converts any workspace to a sit-to-stand workstation. A gentle press to the single handle on one side will activate the gas-spring to raise or lower the monitor and keyboard.

With a total width of 950mm wide, and total depth of 615mm, the StandUp can easily fit on any workstation over 650mm deep. The height adjustment raises or lowers over itself and has no pinch points. Slimline platform is large enough to accommodate multiple items and a special slot on the top surface is designed to accommodate a tablet or phone.

Maximum height achieved fully complies to the New Australian Standards 4442:2018 on a standard 720mm high desk.

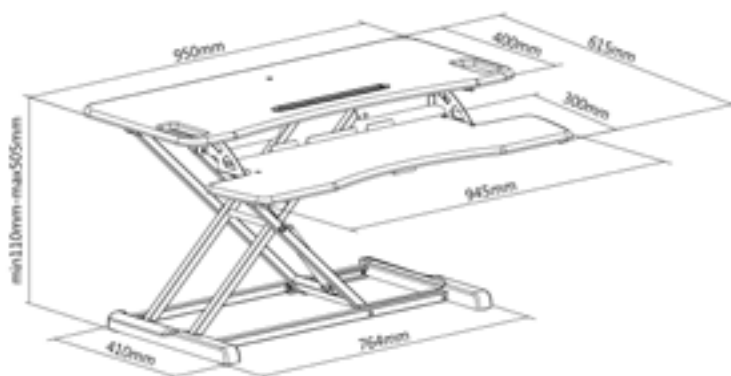

**OVERALL MEASUREMENT**

**SINGLE PRICE  
EXGST & FRIEGHT**

**10+ PRICE**

950mmW x 615mmD

\$455





# ERGONOMIC ACCESSORIES

**STANDUP ELECTRIC**  
2 Button Operation, Quiet Electric Motor,



## STANDUP ELECTRIC

The NEW StandUp Electric Dual effortlessly converts any workspace to a sit-to-stand workstation. Sensor touch buttons effortlessly and quietly adjust height of monitor and keyboard with a height range of 130-460mm.

With a total width of 950mm wide, and total depth of 615mm, the StandUp can easily fit on any workstation over 650mm deep. The height adjustment raises or lowers over itself and has no pinch points. Slimline platform is large enough to accommodate multiple items and a special slot on the top surface is designed to accommodate a tablet or phone.

Maximum height achieved fully complies to the New Australian Standards 4442:2018 on a standard 720mm high desk.

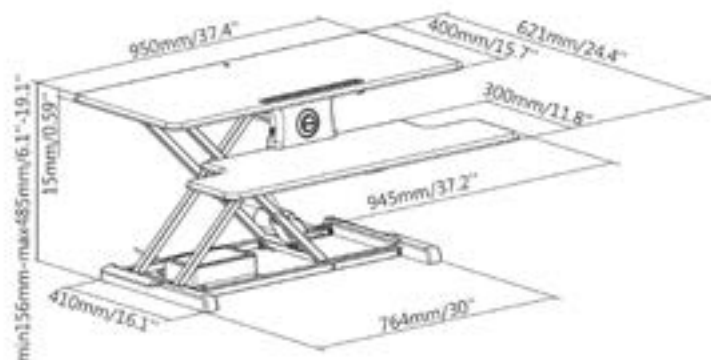

**OVERALL MEASUREMENT**

**SINGLE PRICE  
EXGST & FREIGHT**

**10+ PRICE**

950mmW x 621mmD

\$590



Optional installation and setup available at an additional cost  
Please contact us for a quote.



# ERGONOMIC ACCESSORIES

## ANTI FATIGUE MATT



Easy-grab handle and superior cushioning to make standing comfortable. Bevel safety edge.

Specifications:  
 Colour: Black  
 Size: 915mm x 610mm  
 Thickness: 19mm

| PRODUCT | DESCRIPTION               | SINGLE PRICE<br>EX GST | 20+ PRICE |
|---------|---------------------------|------------------------|-----------|
|         | Non Slip Anti Fatigue Mat | \$119                  |           |

## FOOT REST



Elevates feet and improves circulation. Tilting, sliding footrest encourages movement. Anti-slip to prevent unwanted movement.

Specifications:  
 Colour: Black  
 Size: 480mm x 290mm  
 Height: 95mm

| DESCRIPTION         | STANDARD PRICE<br>EX GST | 20+ PRICE |
|---------------------|--------------------------|-----------|
| Anti-Slip Foot Rest | \$45                     |           |





# ERGONOMIC ACCESSORIES

## STANDUP MONITOR ARM

Weight Rating 15 Kg,  
180 Degree Screen Rotation



Monitor arm with internal cable management, easy to fit VESA 75/100mm plate. Compatible with StandUp portable workstation units. Desk clamp and bolt through options in box. Available in black.

Fully Extendable Reach 430mm for single arm  
Rotation 180 degree (screen)  
Tilt 90 degree (up/down)

| DESCRIPTION                       | STANDARD PRICE<br>EX GST | 20+ PRICE |
|-----------------------------------|--------------------------|-----------|
| Dual VESA 75/100 Plate MonitorArm | \$184                    |           |

## SLIMLINE MONITOR ARM



Sprint action monitor arm with a 3.0 USB charging port per arm and 1 audio headphone port. Easy to fit VESA 75/100mm or 100/100mm plate. Desk clamp or cable port in box. 12 month warranty.

Fully Extendable Reach: 536mm for single arm  
Rotation: 180 degree (screen)  
Tilt: 15 - 90 degree adjustment arc (up/down)

| DESCRIPTION        | STANDARD PRICE<br>EX GST | 20+ PRICE |
|--------------------|--------------------------|-----------|
| Single Monitor Arm | \$145                    |           |
| Dual Monitor Arm   | \$205                    |           |



## CUSTOM CONTROL ROOM SOLUTIONS

Desk Clamp and Bolt Through kit available



Available in fixed head, articulating arm, & dynamic height adjustment. Customisable post heights and rail lengths. Holds any monitor with a VESA mount, from 2kg to 15kg, from 14" to 42". Easy to assemble and adjust, and able to change configurations as monitors change over time.

Direct Ergo has the capacity to design and construct multi monitor mounts to suit any control room requirement. Contact us today to discuss your requirements and how we can help make your workspace more efficient



INDENT ORDER





ILLUSTRATED: WORKZONE ELECTRIC 2C w/ ECHO DOUBLE FLEX DESK MOUNTED SCREEN 1630MMW x 800MMH & UNO CLASSIC MEDIUM BACK

# SCREENS



|                          |    |
|--------------------------|----|
| Aero50mm System          | 56 |
| Cube 30mm System         | 57 |
| Echo System              | 58 |
| Blade System             | 59 |
| Plexa System             | 59 |
| Plexa Room Divider       | 60 |
| Blade Room Divider       | 60 |
| Communicate Room Divider | 61 |
| Modo Room Divider        | 61 |
| Wall Mounted Pinboard    | 62 |
| Peel'N'Stick             | 62 |

# SCREENS

## AERO 50MM SYSTEM

Reconfigurable In Future



The Aero 50mm screen is a versatile, quality workstation screen system, made to order in Australia. Made with Eo board which has zero emissions, the screen design provides a lower environmental impact through the manufacturing process. Designed in Australia, this workstation system offers both ducted and non-ducted panels for ultimate flexibility.

Aero is an investment that can be reconfigured to adapt to a growing office, simply by adding or subtracting panels.



- No Duct Panel, Non Pinnable standard
- Australian Made
- Use with any Desk System
- Choice of White, Silver or Black Powdercoat Finish
- Extended size and colour range options

### OPTIONAL EXTRA'S:

- Mid Panel Ducting
- Base Ducting
- Services Can Be Added (P.O.A)
- Mounting Hardware for any Setup

Screens for workstations give privacy to the workstation and can assist with dampening or reducing office noise. We offer a great range of screens and can customize to suit your office layout.

Please note: all prices are based on house fabric unless otherwise stated. See Page 13 for Range Of colours

| PRODUCT                                                                                                                                                                                                                                   | DESCRIPTION        | HEIGHT x WIDTH |
|-------------------------------------------------------------------------------------------------------------------------------------------------------------------------------------------------------------------------------------------|--------------------|----------------|
|  <p>Aero 50 Desk Mounted Panel</p>  <p>Aero 50 Full Solid Panel</p> | Desk Mounted Panel | 600H x 750W    |
|                                                                                                                                                                                                                                           | Desk Mounted Panel | 800H x 750W    |
|                                                                                                                                                                                                                                           | Desk Mounted Panel | 800H x 1500W   |
|                                                                                                                                                                                                                                           | Desk Mounted Panel | 800H x 1800W   |
|                                                                                                                                                                                                                                           | Full Solid Panel   | 1200H x 1200W  |
|                                                                                                                                                                                                                                           | Full Solid Panel   | 1200H x 1500W  |
|                                                                                                                                                                                                                                           | Full Solid Panel   | 1200H x 1800W  |
|                                                                                                                                                                                                                                           | Base Ducted Panel  | 1200H x 1200W  |
|                                                                                                                                                                                                                                           | Base Ducted Panel  | 1200H x 1500W  |
|                                                                                                                                                                                                                                           | Base Ducted Panel  | 1200H x 1800W  |
|                                                                                                                                                                                                                                           | Mid Ducted Panel   | 1200H x 1200W  |
|                                                                                                                                                                                                                                           | Mid Ducted Panel   | 1200H x 1500W  |
| Mid Ducted Panel                                                                                                                                                                                                                          | 1200H x 1800W      |                |



## AERO SYSTEM Accessories

- Add Pinnable Fabric to Desk Mounted Screen
- Add Pinnable Fabric to 1200H Aero 50mm Screen
- Add Service's Punchouts to Aero w/ Duct
- Workzone Aero Screen - Corner Post 1200H
- Power Pole 2700H - Inc ceiling shroud, Wiring
- End of Run 1200H





## CUBE 30MM SYSTEM

Weight Rating 160 Kg



Use Cube 30mm thick screens to create minimalistic workspaces that reflect the individuals and teams that use them. Cube is highly flexible, and can be configured in straight, 120° and 90° corner workstations.



- No Duct Panel
- Australian Made
- Use with any Desk System
- Choice of White, Silver or Black Powdercoat Finish
- Extended size and colour range options



Screens for workstations give privacy to the workstation and can assist with dampening or reducing office noise. We offer a great range of screens and can customize to suit your office layout.

### OPTIONAL EXTRA'S:

- Mid Panel Glass Panels
- Full Glass Desk Mounted Panel
- Half Melamine Panels

**Please note that the following are only a selection of our standard options, we have plenty of other sizes available, including custom pieces to fit your office space. Discounts apply for volume.**

Please note: all prices are based on house fabric unless otherwise stated. See Page13 for Range Of colours

| PRODUCT                                                                                                                                                                                                   | DESCRIPTION                           |
|-----------------------------------------------------------------------------------------------------------------------------------------------------------------------------------------------------------|---------------------------------------|
| <br><br>Cube 30<br>Full Solid Panel | Desk Mounted Glass Panel 600H x 1500W |
|                                                                                                                                                                                                           | Desk Mounted Glass Panel 600H x 1800W |
|                                                                                                                                                                                                           | Desk Mounted Glass Panel 800H x 1500W |
|                                                                                                                                                                                                           | Desk Mounted Glass Panel 800H x 1800W |
|                                                                                                                                                                                                           | Desk Mounted Panel 500H x 1500W       |
|                                                                                                                                                                                                           | Desk Mounted Panel 500H x 1800W       |
|                                                                                                                                                                                                           | Desk Mounted Panel 800H x 1500W       |
|                                                                                                                                                                                                           | Desk Mounted Panel 800H x 1800W       |
|                                                                                                                                                                                                           | Solid Panel 1200H x 1500W             |
|                                                                                                                                                                                                           | Solid Panel 1200H x 1800W             |
|                                                                                                                                                                                                           | Solid Panel 1500H x 1500W             |
|                                                                                                                                                                                                           | Solid Panel 1500H x 1800W             |



Cube 30  
Desk Mounted Panel



Cube 30  
Translucent Desk Mounted Panel





## ECHO SCREEN SYSTEM

Weight Rating 160 Kg



Our new Workzone Echo Screen Panels are designed with the environment and noise reduction in mind. The highly-functional Echo acoustic panels are ideal for open-planned spaces from commercial offices to educational facilities providing sound absorption and reducing noise.

The contemporary panels offer a standard of ease, flexibility and customisation.

Tested for fire retardancy to comply with Australian building regulations, Echo Panel Noise Reduction Coefficient (NRC) is 0.85"

Illustrated: Echo Express Panel

Please note: all prices are based on house Echo Panel Range unless otherwise stated. See Page 13 For Range of Colours.

### PRODUCT

### HEIGHT x WIDTH

#### ECHO SLIDE ON DIVIDER



300H x 600W  
450H x 750W  
450H x 900W  
600H x 750W  
600H x 900W

#### ECHO DESKTOP DIVIDER



300H x 1750W  
600H x 1200W  
600H x 1500W  
600H x 1800W  
600H x 2100W

#### ECHO DESKTOP HUNG DIVIDER



400H x 1200W  
400H x 1500W  
400H x 1800W  
400H x 2100W  
800H x 1200W  
800H x 1500W  
800H x 1800W  
800H x 2100W

#### ECHO DOUBLE FLEX DESK MOUNTED



800H x 1236W  
800H x 1536W  
800H x 1836W

#### ECHO ON DESK GUARD



600H x 1200W  
900H x 1200W  
600H x 1800W  
900H x 1800W



## BLADE SCREEN

Fabric Wrapped Panel



Workzone Blade Room dividers are designed to divide larger areas into quieter, more functional spaces, providing an easy and cost-effective way to minimize the noise and visual distractions found in today's open work environment.

Constructed from 100% recycled PET materials, Blade dividers absorb up to 85% of ambient noise and easily zip together to create an innovative acoustic solution that allows workers to be more focused and productive while maintaining the benefits of collaboration.

### PRODUCT

### HEIGHT X WIDTH

#### BLADE DESK MOUNTED SCREEN



|              |
|--------------|
| 300H x 1750W |
| 600H x 1150W |
| 600H x 1450W |
| 600H x 1750W |



## Plexa Screen System

6mm Thick System



Sneeze guards, cashier protectors, acrylic barriers, biohazard shields, personal protection shields and cough screens, by any name, they help protect your customers, clients, patients and staff by providing sanitary barriers that reinforce social distancing.

Plexa features 5mm thick clear acrylic panels. Optional side panels attach to the main panel at right angles and provide added protection. Panels slide into place using interlocking tabs. The front panel has a bottom gap to allow for paper transfer.

Plexa Freestanding sits on the countertop, no installation necessary. Fully customizable with options for sizing. Ships ready to assemble.

Illustrated: Plexa Dividing System on B2B Setups

Please note: all prices are based on Translucent Panels unless otherwise stated.

### PRODUCT

### HEIGHT X WIDTH

#### PLEXA FREE STAND-



|                       |
|-----------------------|
| 750H x 900W           |
| 750H x 1200W          |
| 750H x 900W w/ Sides  |
| 750H x 1200W w/ Sides |



#### PLEXA DESKTOP DIVIDER



|              |
|--------------|
| 600H x 1200W |
| 600H x 1500W |
| 600H x 1800W |



## PLEXA ROOM DIVIDER

Combine Straight & Curve For endless Setup



Create stylish privacy in seconds with the new modular screen system. Made from a light bronze tinted ribbed polycarbonate, filtered light is able to past through to brighten work areas but still provides functional privacy.

Join as many straight and curved panels together to create flexible work spaces. These screens allow you to create not only straight and L shape partition but also unique wave, curved and even circular walls and room dividers.

Strong magnets are incorporated into the frame which securely hold panels together without the need for any screws and totally eliminating any gaps.

### DESCRIPTION

- Clear Straight - 1800H x 800W
- Clear Curved - 1800H x 800W
- Clear Straight - 1600H x 800W
- Clear Curved - 1600H x 800W
- Mobile - Clear - 1800H x 1200W



## BLADE ROOM DIVIDER

100% Recycled Materials,  
Absorb 85% Ambient Noise



Workzone Blade Room dividers are designed to divide larger areas into quieter, more functional spaces, providing an easy and cost-effective way to minimize the noise and visual distractions found in today's open work environment.

Constructed from 100% recycled PET materials, Blade dividers absorb up to 85% of ambient noise and easily zip together to create an innovative acoustic solution that allows workers to be more focused and productive while maintaining the benefits of collaboration.

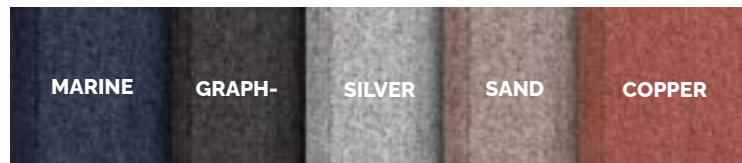

### DESCRIPTION

- Single Screen w/o T-Leg 1650H x 600W
- T-Leg
- 3 Screen Pack w/ T-Legs 1650H x 1800W



## COMMUNICATE ROOM DIVIDER

Pin board & White board Combined



Functional and versatile, the Communicate Room Divider allows you to reshape your workspace or meeting area as required. Choose between a double-sided magnetic whiteboard surface or a charcoal pinnable fabric board on one side.

### Features

- Choose between double-sided magnetic whiteboard surface or charcoal pinnable board on one side
- Easily reshape your workspace or meeting area
- Large lockable 90mm castors
- Supplied with 2 adjustable flipchart hooks
- 150mm magnetic pen tray included
- Dimensions – Width: 950mm, Height: 1875mm
- Buying multiple boards allows you to join them together with the Connector Kit to create a larger dividing wall

### DESCRIPTION

|                                           |
|-------------------------------------------|
| 1 side whiteboard, 1 side Charcoal fabric |
| 2 side whiteboard                         |
| Connector Kit                             |



## MODO PINBOARD

100% Recycled Materials,  
Absorb 85% Ambient Noise



The Modos Vertiface Freestanding Pinboard is a versatile and practical solution for your school or office, with a commercial-quality double-sided pinnable surface mounted on an easily movable frame.

The board is 100% recyclable due to the non-woven velour fabric surface, which is easily pinnable and accepts Velcro – making it ideal for learning environments.

The powder-coated steel frame provides excellent stability due to the T-style legs, with the high quality castor wheels allowing you to easily move the board from room to room.

40 surface colours are available for you to find the perfect pinboard for your space!

### DESCRIPTION

|                             |
|-----------------------------|
| 1500H x 900W - T-Leg        |
| 1500H x 1200W - T-Leg       |
| 1800H x 1000W - T-Leg       |
| 1800H x 1000W - Mobile Base |





## WALL MOUNTED PINBOARD

100% Recycled Materials,



The Wall Mounted Vertiface Frameless Pinboard features a non-woven velour fabric surface fully wrapped around the board to provide a stylish and modern look for your office or classroom.

The board is 100% recyclable, with the surface that is easily pinnable and accepts Velcro – making it ideal for learning environments.

The unique mounting design makes it easy to install the board in portrait or landscape, while stainless steel barrel fixings add to the aesthetic appeal.

40 colours and a range of sizes, including custom, are available so you can create the perfect pinboard to suit your space.

### DESCRIPTION

- [900H x 600W x 30T](#)
- [900H x 900W x 30T](#)
- [1200H x 900W x 30T](#)
- [1200H x 1200W x 30T](#)
- [1500H x 900W x 30T](#)
- [1500H x 1200W x 30T](#)
- [1800H x 900W x 30T](#)
- [1800H x 1200W x 30T](#)
- [2400H x 1200W x 30T](#)



## PEEL'N'STICK TILES

100% Recycled Materials,



Peel 'n' Stick Tiles reduce echo and easily transform walls into acoustic notice boards because of the commercial adhesive backing. The Peel 'n' Stick tiles come in a range of colours, allowing you to mix and match to create designs.

The tiles are 600mm x 600mm that are easily cut to size for a variety of design combinations because of their thin size. The tiles are easy to clean – a light vacuuming on a regular basis will prevent dust build-up and most marks are cleaned with a mild detergent solution followed by rinsing and blotting.

### DESCRIPTION

- [6 pack -600W x 600H](#)
- [Bulk Pack - 38 Same colour tiles](#)
- [Multicolour Multipack](#)





THE BEST QUALITY  
COMPONENTS & MATERIALS,  
FOR THE BEST PRICE.



ILLUSTRATED: NUBLOC TABLE W/ BREEZE 600 PREMIUM

# TASK & EXECUTIVE Chairs



|                     |    |
|---------------------|----|
| Ezone Chair         | 65 |
| Breeze 150 Chair    | 66 |
| Uno Express Chair   | 66 |
| Uno Classic Chair   | 67 |
| Uno Ergo Chair      | 67 |
| Uno Inc Chair       | 68 |
| Evo Chair           | 68 |
| Breeze 600 Chair    | 69 |
| Kaz Executive Chair | 70 |
| Genex 300 Chair     | 70 |
| Genex 600 Chair     | 71 |
| Flexi Mesh Chair    | 71 |
| Genex 200 Slimline  | 72 |
| Clam Lab Stool      | 73 |
| Lab Stool           | 73 |

# TASK CHAIRS

## EZONE CHAIR

Weight Rating 160 Kg



Illustrated: Ezone High Back w/510mm Seats

The Ezone Family is AFRDI Lvl 6 certified. The fully ergonomic mechanism allows back and seat tilt adjustment, and back and seat height adjustment (460-590mm), all adjusted individually from the seated position. The depth of the seat can be increased or decreased by adding a seat slide to the chair.

The Ezone comes standard with a 510mm wide seat, suitable for most people, with options for and 480mm Petite Seat & 530mm Wideboy Seat.

Ezone seats come standard with dual density foam, firmer in the front and softer at the back to encourage good posture and reduce pressure on the lower back.

### OPTIONAL EXTRA'S:

- Medium Back (425-495mm High)
- High Back (515-585mm High)
- Mesh High Back (534mm High)
- 480mm Wide Seat
- 510mm Wide Seat
- 530mm Wide Seat
- Height adjustable arms
- Seat slide
- **Drafting Height w/ Footring (740-980mm H)**
- Heavy Duty Kit (Chrome Base, Reinforced Seat/mechanism to allow 160kg Weight rating)

Please note: all prices are based on house Black fabric unless otherwise stated.

| PRODUCT                                                                                                       | DESCRIPTION                          |
|---------------------------------------------------------------------------------------------------------------|--------------------------------------|
|  <p><b>EZONE CHAIR</b></p> | Medium back w/ 480mm Seat            |
|                                                                                                               | Medium back w/ 510mm Seat            |
|                                                                                                               | Medium back w/ 530mm Seat            |
|                                                                                                               | High back w/ 480mm Seat              |
|                                                                                                               | High back w/ 510mm Seat              |
|                                                                                                               | High back w/ 530mm Seat              |
|                                                                                                               | High Mesh back w/ 480mm Seat         |
|                                                                                                               | High Mesh back w/ 510mm Seat         |
|                                                                                                               | High Mesh back w/ 530mm Seat         |
|                                                                                                               | Heavy Duty w/Medium Back, 530mm Seat |
| Heavy Duty w/High Back, 530mm Seat                                                                            |                                      |
| Add height adjustable arms                                                                                    |                                      |
| Add seat slide                                                                                                |                                      |
| Drafting Kit w/ Foot ring                                                                                     |                                      |



EZONE MESH HIGH BACK w/530MM SEAT, ARMS



EZONE MEDIUM BACK w/ 510MM SEAT, ARMS



EZONE MEDIUM BACK w/510MM SEAT, ARMS, HEAVY DUTY KIT



# TASK CHAIRS

## BREEZE 150

Weight Rating 140 Kg,  
460mm Wide Dual Density Foam Seat



The Breeze 150 offers a desirable balance between comfort, style and budget. The Breeze 150 has user customisable seat height and tilt to reduce pressure on the lower back increase circulation, and has back tilt for added lumbar support.

The chair can be fitted with height adjustable arms for added comfort and an executive look. Seat features moulded foam to adjust to the user's body.

ILLUSTRATED: HIGH BACK BREEZE 150 WITH ARMS

### DESCRIPTION

- Medium back
- High back
- Add height adjustable arms
- Add Seat Slide
- Add Chrome Base
- Add Drafting kit w/ footring



## UNO EXPRESS

Weight Rating 120 Kg,  
460mm Wide, Standard Seat Foam



The Uno Express task chair is an entry level ergonomic task chair. It features a fully ergonomic 3-lever mechanism, gas height adjustment and black nylon base.

The Uno Express comes standard with a 460mm seat & Standard Moulded seat foam.

### DESCRIPTION

### STANDARD PRICE EX GST

### 5+ Price

|                              |       |
|------------------------------|-------|
| Medium back                  | \$305 |
| High back                    | \$320 |
| Add height adjustable arms   | \$40  |
| Add Drafting kit w/ footring | \$75  |



Please note: all prices are based on house Black fabric unless otherwise stated.



# TASK CHAIRS

## UNO CLASSIC

Weight Rating 140 Kg,  
460mm Wide/Dual Density Foam Seat



The Uno Classic combines good ergonomics with superior lumbar support. The Uno Classic chair exceeds OHS standards, is GECA certified and is available under government contract.

Our dual density foam supports the buttocks, lower back and spinal region. Firmer towards the front of the seat and softer towards the back encourages good posture and reduces slouching. The fully recyclable moulded foam encourages good blood circulation.

The Uno Classic comes standard with a 460mm seat & dual density foam, firmer in the front and softer at the back to encourage good posture and reduce pressure on the lower back.

| DESCRIPTION | PRICE EXGST | 5+ Price |
|-------------|-------------|----------|
|-------------|-------------|----------|



- **Drafting Height w/ Footring (740-980mm H)**

|                              |       |
|------------------------------|-------|
| Medium back (400-470mm High) | \$340 |
| High back (520-590mm High)   | \$375 |
| Add height adjustable arms   | \$40  |
| Add Seat Slide               | \$50  |
| Add Drafting kit w/ footring | \$75  |



## UNO ERGO

Weight Rating 140 Kg,  
460mm Wide Waterfall/Deluxe Foam Seat



The Uno Ergo task chair is GECA certified and AFRDI tested to Level 6 which is the highest rating. It exceeds OHS standards and offers superior comfort and adjustment to ensure everybody in your office is comfortable and well supported.

The Uno Ergo features seat height adjustment, seat tilt adjustment and back tilt adjustment. Split dual density foam is standard, encouraging good posture and reducing pressure on the lower back.

The Uno Ergo comes standard with a 460mm waterfall design seat w/ Deluxe Moulded Seat Foam

| DESCRIPTION |
|-------------|
|-------------|



- **Drafting Height w/ Footring (740-980mm H)**

|                              |
|------------------------------|
| Medium back (430-510mm High) |
| High back (520-590mm High)   |
| Add height adjustable arms   |
| Add Seat Slide               |
| Add Drafting kit w/ footring |





# TASK CHAIRS

## UNO INC

Weight Rating 140 Kg, Extra Lumbar Support,  
510mm Wide Waterfall/Dual Density Foam Seat



The Uno Inc task chair is GECA certified and AFRDI tested to Level 6 - the highest rating, and It exceeds OHS standards and offers superior comfort and adjustment to ensure that everybody in your office is comfortable and well supported.

The Uno Inc features Extra Lumbar Support, back and seat height adjustment, seat tilt adjustment and back tilt adjustment. Split dual density foam is standard, encouraging good posture and reducing pressure on the lower back.

The Uno Inc comes standard with a 510mm Waterfall design seat, & dual density foam, firmer in the front and softer at the back to encourage good posture and reduce pressure on the lower back.

### DESCRIPTION

Medium back (440-500mm High)

High back (485-545mm High)

Extra High back (540-600mm High)

Add 530mm Wide Seat

Add height adjustable arms

Add Seat Slide

Add Chrome Base

Add Drafting kit w/ footring



## Evo

Weight Rating 140 Kg, Extra Lumbar Support,  
480mm Wide, Split Dual Density waterfall Seat



The Evo task chair is GECA certified and AFRDI tested to Level 6- the highest rating. It exceeds OHS standards and offers superior comfort and adjustment to ensure everybody in your office is comfortable and well supported.

The Evo features Extra Lumbar Support, Ratchet back and seat height adjustment, seat tilt adjustment and Back tilt adjustment, encouraging good posture and reducing pressure on the lower back.

The Evo comes standard with a 480mm Split Waterfall design seat, & Deluxe dual density foam, firmer in the front and softer at the back to encourage good posture and reduce pressure on the lower back.

### DESCRIPTION

Medium back

High back

Web Back

Add height adjustable arms

Add Drafting kit w/ footring



Please note: all prices are based on house Black fabric unless otherwise stated.



# TASK CHAIRS

## BREEZE 600 CHAIR

Weight Rating 160 Kg



The Breeze 600 Seating Collection combines bold design and brilliant function to deliver a new class in office seating. Designed to perform, the ergonomic chairs in the Breeze 600 range are completely adjustable to provide optimal comfort and support. Available in four styles and a superb array of finishes, the Breeze 600's undeniably modern aesthetic makes it a sophisticated choice for the contemporary office, meeting room or boardroom.

Breeze 600 Feature 3 Version's for Ease of ordering Depending on Budget & Needs, the range is also GECA certified and AFRDI tested to Level 6 which is the highest rating. It exceeds OHS standards and offers superior comfort and adjustment to ensure everybody in your office is comfortable and well supported.

PLEASE NOTE: BREEZE 600 RANGE HAS PRESET OPTIONS.

| PRODUCT                    | HEIGHT (mm) | WIDTH (mm) | DEPTH (mm) |
|----------------------------|-------------|------------|------------|
| Breeze 600 Executive Chair | 970-1060    | 605        | 550        |
| Breeze 600 Premium Black   | 990-1070    | 660        | 570        |
| Breeze 600 Premium White   | 990-1070    | 660        | 570        |
| Breeze 600 Basic Black     | 960-1050    | 670        | 590        |
| Height Adjustable Arms     |             |            |            |



Illustrated: Breeze 600 Executive Chair

### Features:

- High back with adjustable Lumbar Support
- Supportive, high-elastic white nylon mesh back with air flow
- Synchronised mechanism with 4 lockable positions
- Adjustable side tension handle
- Seat sliding function
- Seat stocked in grey fabric
- Polished Steel Arm with Wood Arm Pad
- Polished Aluminium Base



ILLUSTRATED: BREEZE 600 PREMIUM CHAIR IN WHITE

### Features:

- Upholstered, Premium moulded foam seat
- 2D adjustable arms with black arm pads
- Synchronised mechanism with 4 lockable positions
- Adjustable side tension handle
- Seat sliding function
- Seat stocked in black or grey fabric



Illustrated: Breeze 600 Basic Chair

### Features:

- High back with adjustable lumbar support Supportive mesh back
- Standard Moulded Seat Foam
- 2D adjustable arms with black arm pads
- Synchronised tilt with 1 lockable position
- Seat stocked in black fabric



# TASK CHAIRS

## KAZ EXECUTIVE CHAIR

Weight Rating 120 Kg,  
Chrome base as standard



Kaz is a classic chair with light, clean & crisp lines and high quality manufacturing delivering maximum comfort.

Suitable for executive offices, boardrooms & meeting rooms, featuring adjustable seat height, adjustable seat and back angle.

Select from a Medium Back to an High Back, Stocked colour include White, Black & Red.

### DESCRIPTION

Medium back (940-1000mm High)  
High back (1120-1180mm High)



## GENEX MESH 300 MOBILE

Weight Rating 140 Kg,  
Nesting, Folding Chair



Genex Mesh 300 Mobile is a versatile chair that combines executive flair with casual style. Perfect for boardroom meetings or as a flexible workspace chair, the Genex mesh 300 mobile easily flips to allow for increased usable space and easy storage.

The chair's tension back moves with the user for maximum support and comfort. The seat flips up, allowing the chairs to nestle with each other for easy storage.

The Genex Mesh Mobile is perfect for meeting rooms, training rooms, or as an office visitor or breakout chair.

### DESCRIPTION

4-leg, standard chair, no arms  
4-leg, standard chair, fixed arms  
Add Writing Tablet  
Add upholstered back instead of mesh  
Add 5 Star base, with Gas Lift

Please note: all prices are based on house Black unless otherwise stated.



# TASK CHAIRS

## GENEX 600

Weight Rating 160 Kg,  
Chrome base as standard



Genex 600 features the effortless synchronised adjustment. The back and seat move with the operator or can be locked into position. Height adjustable arms can be lowered when typing and adjusted up when required. Standard with seat slide will offer the user the ability to customise the depth of the seat to suit their size.

Features:

- Height Adjustable Arms
- Back Tilt
- Seat Slide
- Height Adjustable Frame
- Ergonomic Lumbar Support
- GECA Approved

### DESCRIPTION

Standard Chair

Please note: all prices are based on house Black unless otherwise stated.



## FLEXI MESH EXECUTIVE

Weight Rating 160 Kg,  
Black powdercoated Metal Base



The Flexi Mesh Exec combines premium styling with exceptional comfort. The chair has been AFRDI tested and approved to level 6, the highest rating, and is also GECA approved.

The Flexi Mesh Exec comes standard with many ergonomic features including:

- Adjustable head-rest
- Adjustable lumbar support
- Seat Depth adjustment
- Multiple locking synchronous mechanism
- Sleek square-line design
- Easy to use, solidly built mechanism with multiple locking positions

### DESCRIPTION

Standard Chair

Please note: all prices are based on house Black unless otherwise stated.





# TASK CHAIRS

## GENEX 200 SLIMLINE

Weight Rating 135 Kg,  
Chrome base as standard



The Genex 200 Slimline is an executive chair offering an ergonomic design to complement most body types. The Genex 200 aims for class and prestige. Ultimately, these aspects of form and function have combined to create the perfect executive chair.

Australian made, so you know that buy this chair you'll be having quality from the first sit.

### FEATURES:

- PU Leather Finish Seat
- Alloy base and class 4 HD gas lift
- Executive knee tilt synchro mechanism with 4 locking positions
- GECA Approved
- Adjustable Seat Height

### OPTIONAL FEATURES:

- Headrest
- Cantilever base\*

Illustrated: High Back With Headrest

### Description

Medium Back without Headrest

High back With Headrest



Please note: all prices are based on house Black unless otherwise stated.



Illustrated: Beige Medium Back Without Headrest



Illustrated: Dark Grey Medium Back Without Headrest





# TASK CHAIRS

## CLAM STOOL CHAIR

Optional Glides or brake castors



Heavy Duty Laboratory Drafting Chair, built for practical and regular use.

AFRDI Level 6 approved, GECA Tested and Approved, ergonomic, durable and provide support exactly where you need it. Two-lever back tilt feature and a manual back height adjustable mechanism, so it can be completely customised to suit your body type, shape and dimensions.

built for purpose and developed for the industrial space, I'm also contemporary and cleanly crafted. Clam Stool is popular with designers, draftspeople, architects and a range of other professionals, built to serve in most settings.

### DESCRIPTION

Standard Chair  
Include Footring



Please note: all prices are based on house Black unless otherwise stated.

## LAB STOOL

Weight Rating 160 Kg



Counter height stool, ideal for labs and short periods of sitting at counter height. Height range 650 – 870mm, with a 390mm round seat.

Upholstered in easy to clean black PU

### DESCRIPTION

Standard Chair



Please note: all prices are based on house Black unless otherwise stated.



# MEETING TABLE SIZE GUIDE

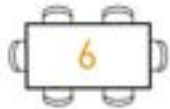

1800 x 900mm



1800 x 900mm



1800 x 900mm



1800 x 900mm



1800 x 1200mm



1800 x 1200mm



1800 x 1200mm



1800 x 1200mm



2100 x 1200mm



2100 x 1200mm



2400 x 1200mm



2100 x 1200mm



2400 x 1200mm



2400 x 1200mm



2700 x 1200mm



2400 x 1200mm



2700 x 1200mm



2700 x 1200mm



3000 x 1200mm



3000 x 1350mm



3000 x 1200mm



3000 x 1200mm



3600 x 1200mm



3600 x 1500mm



3000 x 1350mm



3600 x 1200mm



3600 x 1350mm

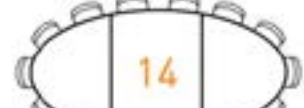

3600 x 1800mm



3600 x 1200mm

# TABLES



|                                   |    |
|-----------------------------------|----|
| Locus Flip Table                  | 76 |
| Flexi Max Flip Table              | 77 |
| Flexi Flip Table                  | 77 |
| Nubloc Table                      | 78 |
| Flexi Meeting Table               | 79 |
| Blade Table                       | 80 |
| Vista Bar Table                   | 80 |
| Stylus Disc Table                 | 81 |
| UR Profile Table                  | 82 |
| Mobile Laptop Table               | 83 |
| Mini-Me Mobile Table              | 83 |
| Pneumatic Lecturn Table           | 83 |
| Height Adjustable Breakroom Table | 83 |

# TABLES

## CITY FLIP TABLE

Weight Rating 180 Kg,  
Better Nesting Ability



The Locus flip table is a more affordable alternative to the City flip table, without compromising on quality. The Locus table is recommended for wider tables due to its low foot design, allowing better nesting when folded.

Available in standard white, silver, or black powdercoat with your choice of melamine top.

Standard table height 695mm (excluding 25mm worktop).

### Specifications

- Strong, Stable Steel frame
- Fixed height 720mm High
- 70mm Castors, 2 Locking Castors to set in place
- Very durable, one handed flip mechanism, simply pull and tilt.
- Multiple tables can nest together
- White, Black, Chrome & Silver Powdercoat finish
- GECA Certified
- Weight Rating 160 Kg
- 10 Year Warranty

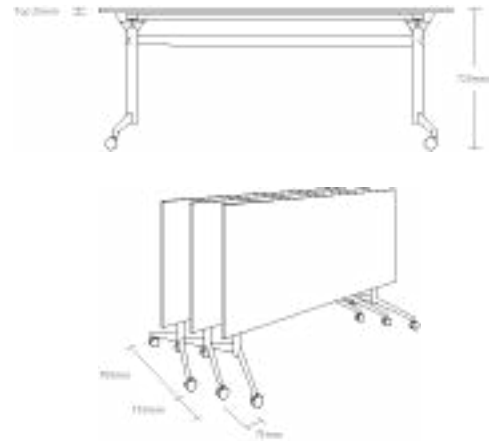

### DESCRIPTION

|                           |
|---------------------------|
| 1200mmW x 600mmD x 720mmH |
| 1200mmW x 750mmD x 720mmH |
| 1500mmW x 750mmD x 720mmH |
| 1500mmW x 900mmD x 720mmH |
| 1800mmW x 750mmD x 720mmH |
| 1800mmW x 800mmD x 720mmH |
| 2100mmW x 750mmD x 720mmH |
| 2100mmW x 900mmD x 720mmH |



\* PRICES BASED OFF WHITE, STANDARD MELAMINE COLOUR RANGE ON PAGE 12,  
SURCHARGE & MANUFACTURING TIME WILL APPLY



# TABLES

## FLEXI MAX FLIP TABLE

Weight Rating 140 Kg,  
Larger Worktop Suitable, Optional Sit to stand Frame



The Flexi Max flip table is the creation for the ever demanding need for flexibility and with the Option of an Manual Winding Height adjustable Worksurface, only available in Black Powdercoat.

With a standard Frame it allows a worktop of 2400mmW x 1200mmD, and on a Height Adjustable frame it allows a 1500-1800mmW x 750-900mmD Worktop.

Constructed out of all metal components ensures a long lasting system, that bears the test of time.

### DESCRIPTION



|                                    |
|------------------------------------|
| 1200mmW x 600mmD x 720mmH          |
| 1500mmW x 750mmD x 720mmH          |
| 1800mmW x 750mmD x 720mmH          |
| 1800mmW x 900mmD x 720mmH          |
| 2100mmW x 900mmD x 720mmH          |
| 2400mmW x 1200mmD x 720mmH         |
| Upgrade to Height Adjustable Frame |



## FLEXI FLIP TABLE

Weight Rating 140 Kg



Our Ever Flexi System comes in the option of Mobile Flip Tables, Built from Study Black Post & Chrome Feet, know that this table will stand the test of time.

Featuring Swilling Locakable Castors, With an strong flip mechanism with a lock for the upright position. Tested upto a AFRDI Lvl 3 - Severe Commercial Use

Standard table height 720mm (including 25mm worktop).

### DESCRIPTION

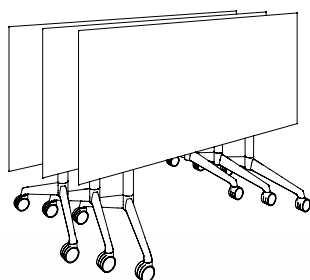

|                           |
|---------------------------|
| 900mmW x 500mmD x 720mmH  |
| 1200mmW x 600mmD x 720mmH |
| 1200mmW x 750mmD x 720mmH |
| 1500mmW x 750mmD x 720mmH |
| 1500mmW x 900mmD x 720mmH |
| 1800mmW x 750mmD x 720mmH |
| 1800mmW x 900mmD x 720mmH |
| 2100mmW x 750mmD x 720mmH |
| 2100mmW x 900mmD x 720mmH |



\* PRICES BASED OFF WHITE, STANDARD MELAMINE COLOUR RANGE ON PAGE 12.  
SURCHARGE & MANUFACTURING TIME WILL APPLY





# TABLES

## NUBLOC TABLE

Weight Rating 140 Kg,  
Timeless Design, Highly Customisable



The NuBloc leg features a timeless classic square leg that will fit into any office or waiting room space.

Highly versatile, this simple desk is available in a wide range of shapes, sizes, and height options, so you will always find one that suits your space.

Available in White or Black Powdercoats

| PRODUCT               | DESCRIPTION                           | WORKTOP               |
|-----------------------|---------------------------------------|-----------------------|
|                       | <b>NUBLOC COFFEE TABLE</b>            | 600W x 600D x 450H    |
|                       |                                       | 900W x 600D x 450H    |
|                       |                                       | 1200W x 600D x 450H   |
|                       | <b>NUBLOC ROUND MEETING TABLE</b>     | Ø900D x 715H          |
|                       |                                       | Ø1050D x 715H         |
|                       |                                       | Ø1200D x 715H         |
|                       | <b>NUBLOC RECTANGLE MEETING TABLE</b> | 900W x 750D x 715H    |
|                       |                                       | 1200W x 600D x 715H   |
|                       |                                       | 1200W x 750D x 715H   |
|                       |                                       | 1200W x 900D x 715H   |
|                       |                                       | 1200W x 1200D x 715H  |
|                       |                                       | 1500W x 600D x 715H   |
|                       |                                       | 1500W x 750D x 715H   |
|                       |                                       | 1500W x 1500D x 715H  |
|                       |                                       | 1800W x 600D x 715H   |
|                       |                                       | 1800W x 750D x 715H   |
|                       |                                       | 1800W x 900D x 715H   |
|                       |                                       | 1800W x 1200D x 715H  |
|                       |                                       | 1800W x 1800D x 715H  |
|                       |                                       | 2100W x 750D x 715H   |
|                       |                                       | 2100W x 900D x 715H   |
|                       | <b>NUBLOC BAR TABLE</b>               | 2400W x 1200D x 715H  |
|                       |                                       | 3600W x 1200D x 715H  |
|                       |                                       | 1200W x 600D x 1050H  |
|                       |                                       | 1500W x 600D x 1050H  |
|                       |                                       | 1500W x 750D x 1050H  |
|                       |                                       | 1800W x 750D x 1050H  |
|                       |                                       | 1800W x 900D x 1050H  |
|                       |                                       | 1800W x 1200D x 1050H |
|                       |                                       | 2100W x 900D x 1050H  |
|                       |                                       | 2400W x 900D x 1050H  |
| 2400W x 1200D x 1050H |                                       |                       |
| 3000W x 750D x 1050H  |                                       |                       |
| 3600W x 750D x 1050H  |                                       |                       |
| 3600W x 1200D x 1050H |                                       |                       |



\* Prices Based Off White, Standard Melamine Colour Range on Page 12, surcharge & Manufacturing time will apply



# TABLES

## FLEXI MEETING TABLES

Most flexibility  
720mm Height



Arcade Tables are designed to fit any office space or meeting size. Beautiful black & chrome frames and many configuration options ensure the tables are as useful as they are stylish.

All components have been tested and GECA certified ensuring maximum points towards your Green Star Building Accreditation.

Feature Highlights:

- Square and rectangle table frames
- Modern combination of black and chrome
- Adjustable levelling feet
- Large range of size and configurations available
- Easy to assemble
- Add power/data for extra functionality



| PRODUCT | DESCRIPTION                            | WORKTOP              |
|---------|----------------------------------------|----------------------|
|         | <b>FLEXI 5 STAR BASE</b>               | Ø600D x 720H         |
|         |                                        | Ø750D x 720H         |
|         |                                        | Ø900D x 720H         |
|         |                                        | Ø1000D x 720H        |
|         |                                        | Ø1200D x 720H        |
|         | <b>FLEXI ROUND MEETING TABLE</b>       | Ø1200D x 720H        |
|         |                                        | Ø1500D x 720H        |
|         | <b>FLEXI SQUARE MEETING TABLE</b>      | 900W x 900D x 720H   |
|         |                                        | 1200W x 1200D x 720H |
|         |                                        | 1500W x 1500D x 720H |
|         |                                        | 1600W x 1600W x 720H |
|         | <b>FLEXI SINGLE POST MEETING TABLE</b> | 2100W x 1100D x 720H |
|         | <b>FLEXI RECTANGLE MEETING TABLE</b>   | 1500W x 900D x 720H  |
|         |                                        | 1800W x 900D x 720H  |
|         |                                        | 1800W x 1200D x 720H |
|         |                                        | 2400W x 1200D x 720H |
|         |                                        | 3600W x 1200D x 720H |
|         |                                        | 3600W x 1800D x 720H |
|         |                                        | 6000W x 1800D x 720H |



\* Prices Based Off White, Standard Melamine Colour Range on Page 12, surcharge & Manufacturing time will apply



# TABLES

## BLADE TABLE

Weight Rating 140 Kg,  
Round/Rectangle 450-720mm High tables



Our Blade table System is Sleek & Contemporary, designed for the Communal spots around the office, the choice of Black or Timber Look Legs, matches any aesthetics

Built from metal constructions  
Standard table height 450mm, 720mm, (including 25mm worktop).

### DESCRIPTION



- Ø1050 x 730mmH (3 Legs)
- Ø1200 x 730mmH (3 Legs)
- 600mmW x 700mmD x 730mmH
- 1200mmW x 750mmD x 730mmH
- 1500mmW x 750mmD x 730mmH
- 1800mmW x 750mmD x 730mmH
- 2100mmW x 750mmD x 730mmH
- 4000mmW x 1000mmD x 730mmH



## VISTA BAR TABLE

Weight Rating 140 Kg,  
Round/Rectangle 1050mm High tables



Our Ever popular Vista workstation comes in a Bar Table variety, we know that when looking to design a officespace the more you can match the surrounding aesthetics the better.

Built on Solid Oak Legs with an Black Accent the has a sturdy base and a clean modern aesthetic.

Standard table height 1050mm (including 25mm worktop).

### DESCRIPTION



- Ø900 x 1050mmH (3 Solid Oak Legs)
- Ø1050 x 1050mmH (3 Solid Oak Legs)
- Ø1200 x 1050mmH (3 Solid Oak Legs)
- 1200mmW x 750mmD x 1050mmH
- 1500mmW x 750mmD x 1050mmH
- 1800mmW x 750mmD x 1050mmH
- 1800mmW x 900mmD x 1050mmH
- 2100mmW x 900mmD x 1050mmH



\* Prices Based Off White, Standard Melamine Colour Range on Page 12,  
surcharge & Manufacturing time will apply



# TABLES

## STYLUS DISC TABLE

Weight Rating 140 Kg,  
Coffee, meeting & bar height







A stylish, timeless table design featuring a polished round base with melamine table top for a classy, clean look. Available in a variety of sizes, this classic table frame will fit into any meeting area, break room or office space.

Standard sizing listed below in coffee table height (425H) or meeting table height (725H).

A selection of standard sizes and prices are listed below, contact our sales team for more information, discounts apply for volume.

Delivery and installation not include.

| PRODUCT                                                                             | DESCRIPTION                           | WORKTOP              |
|-------------------------------------------------------------------------------------|---------------------------------------|----------------------|
|   | <b>STYLUS COFFEE</b>                  | 500W x 500D x 450H   |
|                                                                                     |                                       | 600Dia x 450H        |
|                                                                                     |                                       | 600W x 600D x 450H   |
|                                                                                     |                                       | 750Dia x 450H        |
|                                                                                     |                                       | 900Dia x 450H        |
|                                                                                     |                                       | 900W x 900D x 450H   |
|  | <b>STYLUS ROUND MEETING TABLE</b>     | Ø900D x 725H         |
|                                                                                     |                                       | Ø1050D x 725H        |
|                                                                                     |                                       | Ø1200D x 725H        |
|                                                                                     |                                       | Ø1500D x 725H        |
|                                                                                     |                                       | 800W x 800D x 1050H  |
|  | <b>STYLUS SQUARE BAR TABLE</b>        | 1200W x 1200D x 725H |
|                                                                                     |                                       |                      |
|  | <b>STYLUS RECTANGLE MEETING TABLE</b> | 1500W x 750D x 720H  |
|                                                                                     |                                       | 1500W x 900D x 720H  |
|                                                                                     |                                       | 1800W x 750D x 720H  |
|                                                                                     |                                       | 1800W x 900D x 720H  |
|                                                                                     |                                       | 2100W x 750D x 720H  |
|                                                                                     |                                       | 2100W x 900D x 720H  |
|  | <b>STYLUS D-END TABLE</b>             | 1600W x 1000D x 720H |
|                                                                                     |                                       | 1800W x 1000D x 720H |
|                                                                                     |                                       | 2000W x 1000D x 720H |
|                                                                                     |                                       | 2100W x 1200D x 720H |
|                                                                                     |                                       |                      |



**Note:** D-End tables are not intended to stand alone and must be fixed to a screen, wall, or adjacent table or desk.

\* Prices Based Off White, Standard Melamine Colour Range on Page 12  
surcharge & Manufacturing time will apply



# TABLES

## UR PROFILE TABLE

Weight Rating 140 Kg,  
720mm Height



The UR Profile Table, embodies Style & Sleek design together for a sturdy And customisable table, UR Profile Table can be configured for a meeting table all the way to a cluster work space setup.



Standard Frames are White or Black Powdercoat and with the option of Polished Alloy frame

UR Profile Meeting Tables are a sleek look for small-large meeting rooms. The frames are stocked in three colours, and can be set up in 3 leg or 4 leg settings.

UR Profile Boardroom Tables are a tidy, slimline frame that add class to the boardroom setting. The frames can be set up in 4,6,8 leg configurations, creating tables from 1800mm to 6000mm long.

### DESCRIPTION

|                                                                                     |                                                                                                                                                                                                                                                                             |                                                                                       |
|-------------------------------------------------------------------------------------|-----------------------------------------------------------------------------------------------------------------------------------------------------------------------------------------------------------------------------------------------------------------------------|---------------------------------------------------------------------------------------|
|  | <p>900mmW x 900mmD x 720mmH (4 Legs)</p> <p>Ø900 x 720mmH (3 Legs)</p> <p>Ø1200 x 720mmH (3 Legs)</p>                                                                                                                                                                       |  |
|  | <p>1500mmW x 750mmD x 720mmH</p> <p>1800mmW x 750mmD x 720mmH</p> <p>1800mmW x 900mmD x 720mmH</p> <p>1800mmW x 1200mmD x 720mmH</p> <p>1800mmW x 1500mmD x 720mmH</p> <p>2100mmW x 900mmD x 720mmH</p> <p>2400mmW x 1200mmD x 720mmH</p> <p>2400mmW x 1500mmD x 720mmH</p> |                                                                                       |
|  | <p>3600mmW x 1200mmD x 720mmH</p> <p>4800mmW x 1200mmD x 720mmH</p> <p>6000mmW x 1800mmD x 720mmH</p>                                                                                                                                                                       |                                                                                       |

\* Prices Based Off White, Standard Melamine Colour Range on Page 12, surcharge & Manufacturing time will apply





# TABLES

## MOBILE LAPTOP TABLE

Weight Rating 140 Kg,



The Mobile Laptop Desk is the necessary ergonomic accessory every collaborative learning space needs. It's light weight and features a 260mm height range perfect for creating desks out of lounge and other tub chair seating, providing a solution for the overcrowding experienced in libraries or similar environments.

Features:

Dimensions: 600x365mm

Height Range: 720mm-980mm

On Castor wheels for easily mobility

### DESCRIPTION

600mmW x 365mmD

## MINI ME PORTABLE DESK

Weight Rating 140 Kg,

720-1020mm Height Range



The Ergonomic Sit to Stand Desk Mini Me can be used as a mobile freestanding sit to stand desk at home or in an office or any environment where you need a height adjustable table. Mini Me uses an innovative counter-balance mechanism to enable you to instantly and effortlessly make height adjustments.

### DESCRIPTION



#### MINI-ME

700W x 400D x 720-1020mmH



#### PNEUMATIC LECTURN TABLE

600mmW x 600mmD x 750-1120H



#### HEIGHT ADJUSTABLE BREAK-ROOM TABLE

800 Dia x 688 - 1058H





# VISITOR Chairs



|                   |    |
|-------------------|----|
| Sonia Chair       | 86 |
| Paris Chair       | 86 |
| Webar Chair       | 87 |
| Pixar Chair       | 87 |
| Lola Chair        | 88 |
| Arrow Chair       | 88 |
| Game Chair        | 89 |
| Stax Chair        | 89 |
| Abby Chair        | 90 |
| Romba Chair       | 90 |
| Luna Chair        | 91 |
| Genex Mesh Mobile | 91 |
| Tidy Chair        | 92 |
| Balance Chair     | 92 |
| Clue Chair        | 93 |
| Zenra Chair       | 93 |



# VISITOR SEATING

## SONIA CHAIR

Weight Rating 140 Kg  
Sled Base, Stackable



A very popular breakout chair, meeting all criteria for comfort, design and durability at an economical price.

### PRODUCT

### DESCRIPTION



Chrome Sled Base, Plastic Seat & Back  
Sled Base, Upholstered Seat  
Add Writing Tablet



## PARIS CHAIR

Weight Rating 140 Kg  
Sled Base, Stackable



The Paris Visitor Chair features a classic European design suitable for any cafe, casual meeting area, or communal space. Available in black or white polypropylene shell with matching powder coat sled base, or green shell with chrome sled base.

### PRODUCT

### DESCRIPTION

White shell, white sled base  
Black shell, black sled base  
Lime Green shell, Chrome sled base



# VISITOR SEATING

## WEBAR CHAIR

Weight Rating 140 Kg

Optional Underseat Book Rack & Tablet Arm



Webar Visitor chairs a versatile and durable chair that is are easily stackable and feature a Webbed back which allows for a little flex for comfort.

Comes standard with slim line chrome sled base and black acrylic shell with Foot glides.

Perfect as an visitor, breakout, student, reception, auditorium or meeting/training chair.

### PRODUCT

### DESCRIPTION

Standard Sled base

Add Book rack

Add Tablet Arm



## THE PIXAR CHAIR

Durable Learning & Breakroom



Pixar chairs a versatile and durable chair that is are easily stackable and have a handle-like back which allows easy reconfiguration. It is AFRDI tested and approved. Can be used as visitor, breakout, student, reception, auditorium or meeting/training chair.

Pixar visitor chair comes standard with slim line chrome sled base and your choice of black or white acrylic shell. Optional Features include upholstered seat cushion, upholstered back cushion, or removable Tablet Arm. Also available in bar stool height.

### DESCRIPTION

Acrylic shell

Upholstered seat

Upholstered seat and base

Additional tablet arm

Bar stool height, acrylic shell

Bar stool height, upholstered seat & back





# VISITOR SEATING

**LOLA CHAIR**  
Weight Rating 140 Kg,  
Classic Shape, Stackable



The Lola is has a classic shape and easily stackable. Perfect for break rooms and multi-purpose areas, these chairs are comfortable and stylishly simple, and stack away easily for storage.

The Lola comes standard with a 4-leg chrome frame and white seat. Alternative colours and designs are available, and upholstered options are available in a variety of colours. Standard Lola has a 4 leg chrome frame and white seat. Optional Features include black and white or red and white colouring, and fully upholstered seat and back.

## PRODUCT

## DESCRIPTION



4 Leg Chrome Frame  
Chrome Sleb Base



# ARROW CHAIR

Weight Rating 140 Kg,  
Stackable, Upholstered Option



A contemporary modern chair design with single mold textured polypropylene shell. This is a stylish sophisticated chair suited to today's modern environment.

This chair not only looks great but is strong enough to withstand heavy duty, commercial use due to its solid construction and quality craftsmanship. Ideally suited for use in restaurants, clubs, food courts, hotels and corporate breakout areas.

**Construction:** Steel tube sled base construction in factory chrome or black powdercoated finish.

## PRODUCT

## DESCRIPTION



- Sled Base
- Sled Base w/ Upholstered Seat
- Sled Base & Fully Upholstered
- Naked w/ Timber Base
- Upholstered w/ Timber Base
- Naked w/ 4 Star Base
- Naked w/ 4 Star Castor Base
- Upholstered w/ 4 star base



# VISITOR SEATING

## GAME CHAIR

Weight Rating 140 Kg,



Go higher and make connections with the Game Chair! Thoughtfully designed with low profile frame and ergonomically contoured seat & back, the Game chair nests well to save space and is very portable. Feet that double as connectors and a modern colour selection make the Game a stand out choice for any place large numbers of people need to be seated. Recommended for use as Training, Conference, Classroom, Healthcare, Retail & Cafeteria Seating.

### PRODUCT

### DESCRIPTION



- Standard Chair, 4 legs
- Standard Chair, Sled Base
- Upholstered seat pad
- Upholstered Seat & Back
- Sled base w/ Antibacterial treatment
- Bar stool



## STAX CHAIR

Weight Rating 140 Kg  
Sled Base, Stackable



The Stax is a stylish and comfortable visitor chair with a rounded backrest. The specially contoured seat and back provide excellent support and the protective outer covers minimise high impact wear and tear.

Heavy gauge tubular steel frame powder-coated black, guarantees years of use and durability. The standard Stax features black fabric seat and back, with a black frame.

### OPTIONAL FEATURES

- include fixed arms
- chrome frame
- polyurethane full back.

### PRODUCT

### DESCRIPTION

- Standard Stax, standard upholstery
- Standard Stax, standard upholstery, arms
- Sled base, standard upholstery
- Sled base, standard upholstery, arms



# VISITOR SEATING

## ABBY CHAIR

Weight Rating 140 Kg,  
Larger Worktop Suitable, Optional Winding Frame



A very popular chair, meeting all criteria for comfort, design and durability at an economical price.

The Abby features ergonomically designed contoured seats and backs, to provide day-long comfort and support, ideal for all applications of seating. Available with a fully upholstered seat and back. It is AFRDI and GECA certified.

Standard Abby features black fabric seat and back, with a black frame.

### PRODUCT

### DESCRIPTION

Standard Chair, No Arms  
Standard Chair, With Arms  
Mesh Back upgrade



## ROMBA CHAIR

Weight Rating 140 Kg  
Sled Base, Stackable



This simply designed visitor chair comes standard with chrome steel rod, polypropylene seat and back, and link-ing device for easy auditorium seating.

Standard Romba features a white plastic seat on metal frame. Optional features include arms, mesh back, upholstered seat pad, upholstered back, writing tablet, parcel tray, moving trolley and bar stool height.

### Product

### DESCRIPTION



Sleb Base, Stackable  
Sled Base, Plastic Mesh Back, Stackable  
Sled Base, Upholstered Seat, Stackable  
Sled Base, Full Upholstered, Stackable  
Add Writing Tablet



# VISITOR SEATING

## LUNA CHAIR

Weight Rating 140 Kg,  
Blend of Modern & Retro



The Luna chair indoor collection combines modern and retro aesthetics for informal zone and small meeting areas.

Choose from either black or white flexible polypropylene shell, and a natural oak frame.

The seat cushion is upholstered in your choice of 10 high quality Motion Felt colours, or Eurotex PU in white or black.

### PRODUCT

### DESCRIPTION



- Oak 4 leg frame
- 4 leg metal frame
- 4 Leg bar frame



## GENEX MESH MOBILE

Complete Mutli Purpose



Genex Mesh Mobile is a versatile chair that combines executive flair with casual style. Perfect for boardroom meetings or as a flexible worksapce chair, the Mesh Mobile easily flips to allow for increased usable space and easy storage.

The chair's tension back moves with the user for maximum support and comfort. The seat flips up, allowing the chairs to nestle with each other for easy stor- age.

The Genex Mesh Mobile is perfect for meeting rooms, training rooms, or as an office visitor or breakout chair.



### DESCRIPTION



- 4-leg, standard chair, no arms
- 4-leg, standard chair, fixed arms
- 4-leg, fixed arms, tablet arm
- Option Fully Upholstered
- Option Vinyl Upholstery





# VISITOR SEATING

## TIDY CHAIR

Weight Rating 160 Kg



Illustrated: Tidy Chair on Chrome Sled Base

The Tidy is a comfortable and conservative visitor chair. The chair is easily customised in a variety of colours to suit any location and is easily stackable to conserve space.

The standard Tidy comes with polished silver sled base and upholstered seat and back in black ecolabel fabric.

The Tidy is GECA and AFRDI Certified, stackable, and comes standard with a 430mm wide seat.

### PRODUCT

### DESCRIPTION

[Tidy Chair on Chrome 4 Legs](#)  
[Tidy Chair on Chrome Sled Base](#)



## BALANCE CHAIR

Weight Rating 140 Kg  
 Mobile or Cantilevered Bases



The Balance Visitor chair is a great option for a variety of spaces from an executive side chair, conference seating or for use in a training or boardroom.

The fold up seat allows for nesting to save space when not in use. It has integral arms and the high quality supportive black mesh backrest combines for flexible comfort. The seat of moulded foam and hard wearing fabric makes it great for high use areas.

### PRODUCT

### DESCRIPTION



[Chair without arms](#)  
[Chair with arms](#)  
[Cantilever Chair](#)





# VISITOR SEATING

## CLUE CHAIR

Weight Rating 140 Kg,  
Classic Shape



Cut from the right cloth.

Light, stylish and comfy, with a beautiful sculpted back that gently moves with the user's bodyweight. The Clue is available in a range of bases and finishing options to meet any requirements.



### Features:

- Polypropylene shell with gentle controlled flex back
- Chair frame options: 4 leg, sled base, 4 leg timber or 5 star base on castors with height adjustment
- Stackable (4 leg & sled base only | 6 high w/o arms)
- Polypropylene shell colours: White, Red, Black, Grey, Army Green, Light Blue, Mustard, Brown, Sage Green, Turtledove, Sand (NOTE: Some finishes may be indent)
- Upholstery (seat pad & back upholstered): Select from house fabrics or fabric of your choice

### PRODUCT

### DESCRIPTION



Naked, Timber base  
upholstered, Timber Base  
Naked, Sled base  
Upholstered inner shel, 4 leg swivel base



## ZENRA CHAIR

Weight Rating 140 Kg  
Sled Base, Stackable



With a touch of mid-century modern flair and contemporary design features, Zenra Chairs are a striking choice for reception, waiting room or breakout areas. Featuring full upholstered shells with arms, wide backs and timber and metal base options, the chairs are available in a range of contemporary fabric colours.



### Features:

- Dimensions (mm): 830H x 570W x 620D (Approx. 450SH)
- Fully upholstered with arm rests
- Timber and metal base options
- Ribbed pattern detail of upholstery only available in Arena fabric

### PRODUCT

### DESCRIPTION



Timber Base, Grey fabric upholstery  
Timber Base, Real Leather upholstery  
Sled base, Grey fabric upholstery



# ADAPTING TO THE INCREASING NEED TO REMOVE BACTERIA



# HEALTHCARE

## Seating



|                                 |     |
|---------------------------------|-----|
| Bella & Woody Chairs            | 96  |
| Jackal & Alfred                 | 97  |
| Zig & Josh Chairs               | 98  |
| Rota & Senna Chairs             | 99  |
| Vinny & Ambass Chairs           | 100 |
| Tranfusion Sofa Bed             | 101 |
| Sick Bay Bed & Foy Beam Seating | 102 |
| Max & Laser Beam Seating        | 103 |
| Goldy & Tia Tub Chairs          | 104 |
| Alice Tub Chair & Senna Ottoman | 105 |
| Genex Mesh Mobile               | 106 |
| Pixar Chair & Barstool          | 107 |

## BELLA CHAIR

Long Term Comfort



The Bella Chair is a long-term comfort guest chair. Featuring a timeless design & built for strength and durability, Bella is suitable for use in Healthcare & Aged Care facilities. The maple colour wood finish sets off a modern fresh look making it a welcome addition to any Healthcare & Aged Care facility.



### PRODUCT DETAILS

Heavy duty 2 pack polyurethane lacquer  
 Quality high density foam  
 Gin Rummy (Gravel) upholstery (standard)  
 Adjustable height leveling glides  
 Weight Capacity 160kg

### DESCRIPTION

Medium Back



## WOODY CHAIR

Stackable



The Woody chair is a modern take on the traditional guest chair, with an Plywood frame construction its sturdy but also lightweight, it features a comfortable padded seat & back, with curved armrest for added comfort and support.



### PRODUCT DETAILS

Dimensions 830H x 530W x 590Dmm  
 Weight Capacity 110kg  
 Stackable Yes  
 Warranty 10 Year

### DESCRIPTION

Medium Back, No arms  
 Medium Back, With arms





## JACKAL CHAIR Traditional



The Jackal chair is our traditional chair for the Aged health-care industry, the difference we used a quality wooden frame with an upholstered seat and back in Mocha as standard, for those times you need a chair in a rush.

Jackal can be re-upholstered in fabric or vinyl of your choosing

Dimensions 960H x 530W x 670Dmm

Weight Capacity 120kg

Stackable No

Warranty 10 Years



### DESCRIPTION

High Back



## ALFRED CHAIR Height Adjustable



The Alfred Chair comes standard with Height Adjustable leg's, made in Australia the Alfred features 175mm of adjustment in height, and the use of a steel fully welded frame gives the chair quality and durability for years to come.

Dimensions 985-810H x 600W x 450Dmm

Weight Capacity 130kg

Stackable No

Warranty 10 Year



### DESCRIPTION

Medium back, with height adjustable Legs





## ZIG CHAIR

Height Adjustable Comfort



Steel fully welded frame with upholstered seat and back  
 Armrests and optional arm pads for added comfort and support, Adjustable legs to adjust seat height as required  
 Australian made



### PRODUCT DETAILS

Dimensions 960-800H x 565W x 585Dmm  
 Weight Capacity 130kg  
 Warranty 10 Year

### DESCRIPTION

- No Arm Pads, No Adjustable Legs
- With Arm Pads, No Adjustable Legs
- No Arm Pads, With Adjustable Legs
- With Arm Pads, With Adjustable Legs



## JOSH CHAIR

Linkable



4 Leg fully welded Steel Frame, upholstered seat & back  
 Optional Armrests for added comfort  
 Optional links to join chairs as required  
 Convert to a lecture chair with tablet arm

Fabric Range: Black, Charcoal, Navy, Burgandy, Pacific Blue,

### PRODUCT DETAILS

Dimensions 780H x 560W x 580Dmm  
 Weight Capacity 110kg  
 Stackable No  
 Warranty 10 Year



### DESCRIPTION

- Standard Chair
- Standard Chair w/ Sled Base
- Standard Chair With Arms
- Standard Chair, Linkable Version
- Standard Chair, with Tablet Arm



## ROTA CHAIR Heavy Duty



Heavy duty black textured metal frame  
High density foam  
Available in 2 seat widths  
Plastic under pan  
Available in local fabrics

### PRODUCT DETAILS

Dimensions Rota600: 700H x 330W x 630Dmm  
Rota700: 700H x 630W x 630Dmm  
Weight Capacity 200kg  
Stackable No  
Warranty 10 Year



ROTA 700

### DESCRIPTION

[330mm Wide Seat](#)  
[630mm Wide Seat](#)



## SENNA CHAIR Lightweight



Steel oval tube frame  
Polypropelene seat and back  
Optional castors

### PRODUCT DETAILS

Dimensions 850H x 570W x 580Dmm  
Weight Capacity 100kg  
Stackable Yes  
Warranty 10 Year

### Frame Colour

Black or Silver

### Seat Colour

Black Polypropylene  
Red Polypropylene  
White Polypropylene



### DESCRIPTION

[Standard Chair](#)  
[Add castors to legs](#)



## VINNY CHAIR

Contoured Height Adjustable Comfort



Steel fully welded frame with upholstered seat and back  
 Moulded and contoured shell shape with high density foam for comfort over long periods  
 Suitable for high use applications  
 PU ergonomic arms pads for added comfort & support  
 Adjustable legs as standard to adjust seat height  
 Transit wheels as standard on back legs for easy manouver-ability  
 Australian made



### PRODUCT DETAILS

Dimensions: 1 270-1090H x 670W x 660Dmm  
 Weight Capacity 250kg  
 Stackable No  
 Warranty 10 Year  
 Weight Capacity 250

### DESCRIPTION

Low Back  
 High Back  
 Low Back Non-adjustable legs  
 High Back non-adjustable legs



## AMBASS CHAIR

Wipable Waiting Chairs



Fully welded steel frame with upholstered seat and back  
 Moulded and contoured shell shape with high density foam for comfort over long periods  
 Suitable for high use applications  
 PU ergonomic arm pads for added comfort & support  
 Australian made



### PRODUCT DETAILS

Dimensions 880H x 1 Seater 650W; 2 seater-1230W; 3 seater-1800W x 660Dmm  
 Weight Capacity 1 Seater 150kg; 2 seater-300kg; 3 seater-450kg  
 Stackable No  
 Warranty 10 Year

### DESCRIPTION

Single seater w/ PU arm pads  
 2 Seater w/ PU arm pads  
 3 Seater w/ PU arm pads



## TRANSFUSION SOFA BED Styled Patient



### Features:

- high density foam
- Recline back function and extension footrest.
- Ash wood swivel hand rest to improve comfort during infusion.
- Upholstered in elephant medical-grade vinyl upholstery

elephant series vinyl

Hospital grade vinyl, corrosion resistance, anti static, flame retardant, waterproof, formaldehyde free, mildrew resistant, antibacterial and antifungal.



### DESCRIPTION



- Sofa bed without electronics
- Sofa bed w/ electronic recliner



## SOFA BED Styled Dining Room



### Features:

- medical-grade vinyl upholstery
- high density foam
- chrome metal with wheels

elephant series vinyl

Hospital grade vinyl, corrosion resistance, anti static, flame retardant, waterproof, formaldehyde free, mildrew resistant, antibacterial and antifungal.



### DESCRIPTION

Caribbean fabric



## SICKBAY BED

Australian Made, Sturdy Construction, customisable



The Sick Bed - Melamine is constructed from steel frame with sturdy melamine box and fitted with foam cushioning on ply base and back with an adjustable back rest. It comes upholstered in a durable vinyl finish making it easy to clean.

Proudly Australian made, the Sick Bay Bed - Melamine is a functional solution for school health rooms or any other medical room. Made to order in a wide range of vinyl or board colours.



### DESCRIPTION

500H x 1800L x 600D



## FOY CHAIR

Wipable Beam Seating



Seat and back are made from a hydraulically moulded steel plate

Arms and feet are made from die cast moulded high strength aluminium alloy

Frame is coated using an electrostatic coating and polishing following rust proof treatment

Seat and back is made from cold consolidated foam which forms a high density and super soft PU

### PRODUCT DETAILS

Dimensions Overall: 875H x 640Dmm

Widths of each Size: 2 seater-1200W, 3 seater-1810W,  
4 seater-2400W, 5 seater-2990W.

Weight Capacity: 2 seater-220kg; 3 seater-330kg;  
4 seater-440kg; 5 seater-550kg



- 3 Seater
- 4 Seater
- 5 Seater
- Add arms





## MAX BEAM SEATING Modern Waiting Room



Optional fully upholstered back or mesh  
 Optional 2, 3 or 4 seater  
 Suitable for indoor use only  
 Plastic under pan  
 Plastic outer back  
 Adjustable feet  
 Black metal frame



### PRODUCT DETAILS

Available in local fabrics  
 Back mesh available in Jazz mesh  
 Weight limit for 2 seater is 200kg  
 Weight limit for 3 seater is 300kg  
 Weight limit for 4 seater is 350kg

### DESCRIPTION

- |                              |
|------------------------------|
| 2 seater w/ Mesh back        |
| 2 seater, Upholstered back   |
| 3 seater w/ Mesh back        |
| 3 seater w/ Upholstered back |
| 4 seater w/ Mesh back        |
| 4 seater w/ Upholstered back |



## LASER BEAM SEATING Modern Waiting Room



### Features & Add-ons:

- KD Steel frame with upholstered seat and back
- Optional Armrests between each seat or end arms only, for added comfort
- Optional coffee table inserted in place of a seat



### DESCRIPTION

- |                              |
|------------------------------|
| 2 seater, Upholstered back   |
| 3 seater w/ Upholstered back |
| 4 seater w/ Upholstered back |
| 5 seater w/ Upholstered back |
| Add arm                      |
| Add Table                    |



## GOLDY TUB CHAIR Styled Patient



Plywood shell  
 Optional chrome sled base  
 Optional 700mm chrome 4 leg frame  
 Optional high arch aluminium 4 star base  
 Optional natural or black laminate timber legs  
 Optional black base  
 Optional black base with castors  
 High density foam  
 Adjustable seat height with 4 star base  
 Suitable for indoor use only



Available in local fabrics

10 Year warranty  
 Weight limit is 130kg

### DESCRIPTION

|                                                 |
|-------------------------------------------------|
| 4 Leg Chrome Legs                               |
| Optional Chrome Sled Base                       |
| Optional Black High Arch 4 star Base No Castors |
| Optional 4 Leg Natural or Black Timber Legs     |
| Optional Black Base with Castors                |



## TIA TUB CHAIR Styled Dining Room



The Tia is modern, steel framed armchair with steel inner frame and moulded foams for durability  
 Suitable for a variety of functions including dining and semi-formal seating areas as well as a lounge and bedroom chair.

Available in Stock Fabrics with Wooden Legs or Disc Base  
 Also Available Upholstered to Specification.  
 Safe Working Load 130kg  
 Overall Width: 57  
 Overall Height: 69  
 Overall Depth: 55  
 Seat Width: 45  
 Seat Depth: 46  
 Seat Height: 45  
 Warranty: 10 Year Structural



### DESCRIPTION

|                           |
|---------------------------|
| House Fabric, Wooden Legs |
| House Fabric, Disc Base   |



## ALICE TUB CHAIR Styled Waiting Room



The Alice is modern, steel framed armchair with steel inner frame and moulded foams for durability  
Suitable for a variety of functions including dining and semi-formal seating areas as well as a lounge and bedroom chair.

Available Upholstered to Specification.  
Minimum Order Quantities Apply  
Safe Working Load 130kg

Dimensions: Overall Width: 61  
Overall Height: 87  
Overall Depth: 63  
Seat Width: 46  
Seat Depth: 48  
Seat Height: 46  
Warranty: 5 year Structural



### DESCRIPTION

Timber legs  
Star Wire Base



## SENNA CHAIR Movable Seating



Solid timber frame  
Plastic legs  
High density foam  
Suitable for indoor use only  
Available in local fabrics  
Optional Round, Square & Triangle Shape  
10 Year warranty  
Weight limit is 120kg



### DESCRIPTION

Round Shape  
Square Shape  
Triangle Shape



## GENEX MESH MOBILE Complete Mutli Purpose



Genex Mesh Mobile is a versatile chair that combines executive flair with casual style. Perfect for boardroom meetings or as a flexible worksapce chair, the Mesh Mobile easily flips to allow for increased usable space and easy storage.

The chair's tension back moves with the user for maximum support and comfort. The seat flips up, allowing the chairs to nestle with each other for easy storage.

The Genex Mesh Mobile is perfect for meeting rooms, training rooms, or as an office visitor or breakout chair.



### DESCRIPTION



4-leg, standard chair, no arms  
4-leg, standard chair, fixed arms



4-leg, fixed arms, tablet arm





## PIXAR CHAIR Durable Learning



Pixar chairs a versatile and durable chair that is are easily stackable and have a handle- like back which allows easy reconfiguration. It is AFRDI tested and approved. Can be used as visitor, breakout, student, reception, auditorium or meeting/training chair.

Pixar visitor chair comes standard with slim line chrome sled base and your choice of black or white acrylic shell. Optional Features include upholstered seat cushion, upholstered back cushion, or removable Tablet Arm. Also available in bar stool height.



### DESCRIPTION

- [Acrylic shell](#)
- [Upholstered seat](#)
- [Upholstered seat and base](#)
- [Additional tablet arm](#)



## PIXAR BARSTOOL Durable Breakroom



Pixar chairs a versatile and durable chair that is are easily stackable and have a handle- like back which allows easy reconfiguration. It is AFRDI tested and approved. Can be used as visitor, breakout, student, reception, auditorium or meeting/training chair.

Pixar Bar Stool comes standard with slim line chrome sled base and your choice of black or white acrylic shell. Optional Features include upholstered seat cushion, upholstered back cushion, or removable Tablet Arm.



### DESCRIPTION

- [Bar stool height, acrylic shell](#)
- [Bar stool height, upholstered seat & back](#)





INCREDIBLE FLEXIBILITY  
& COLLABORATION  
FOR ANY WORKSPACE



# COLLABORATIVE Seating



|                  |     |
|------------------|-----|
| Focus Seating    | 110 |
| Shield Seating   | 111 |
| Flow Lounges     | 112 |
| Park Lounges     | 114 |
| Quiet Booth      | 116 |
| Sara Seating     | 117 |
| Arc Movement     | 117 |
| Pebble Ottoman   | 118 |
| Otta Ottoman Mix | 119 |
| Vera Lounge      | 120 |
| Samal Lounge     | 120 |

# SOFT SEATING

## FOCUS SEATING







Australian Made and offering a variety of beautiful fabric options, this lounge is a stylish addition to any workplace. Features non-removable cushions to ensure longevity of the lounges in the unpredictable education environment.

Made with quality full fire retardant foam. Direct Ergonomics also offer a range of coffee tables/and or laptop tables to go with the lounges. GECA Certified and Australian made locally in NSW.

Optional Features:

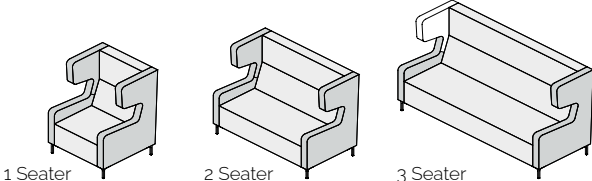
- Two Tone Upholstery
- Regular (1170H) or Tall Back (1570H)
- 1, 2, 2.5, and 3 seater options
- Available in any fabric colour to suit your colour scheme.

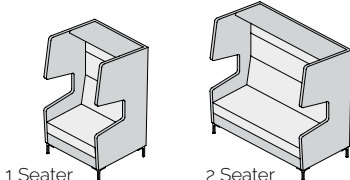
PLEASE NOTE: ALL PRICES ARE BASED ON NO FABRIC UNLESS OTHERWISE STATED.

| PRODUCT                                                                                                           | DESCRIPTION                                                                                                                                                 | FABRIC REQUIRED | DIMENSIONS           |
|-------------------------------------------------------------------------------------------------------------------|-------------------------------------------------------------------------------------------------------------------------------------------------------------|-----------------|----------------------|
| <b>FOCUS STANDARD BACK</b><br> | Focus 1 Seater                                                                                                                                              | 9m              | 1170H x 740W x 770D  |
|                                                                                                                   | Focus 2 Seater                                                                                                                                              | 15.5m           | 1170H x 1340W x 770D |
|                                                                                                                   | Focus 3 Seater                                                                                                                                              | 21m             | 1170H x 1940W x 770D |
|                                                                                                                   | <input type="checkbox"/> Fabric A <input type="checkbox"/> Fabric B<br> |                 |                      |
| <b>FOCUS TALL BACK</b><br>     | Focus 1 Tall Seater                                                                                                                                         | 12.5m           | 1170H x 740W x 770D  |
|                                                                                                                   | Focus 2 Tall Seater                                                                                                                                         | 19m             | 1170H x 1340W x 770D |
|                                                                                                                   | <input type="checkbox"/> Fabric A <input type="checkbox"/> Fabric B<br>  |                 |                      |
|                                                                                                                   |                                                                        |                 |                      |

### Specifications

Available in Any Fabric to suit you colour scheme

Refer to Page 14 for house Range, Caprio & Cashmere

Manufactured in Australia, within 5-6 Week lead time

Note: Custom two-toned upholstery orders (outside standard two-tone specifications) may incur additional charge.

Collaborative seating range not available for online ordering



# SOFT SEATING

## SHIELD SEATING



Collaborative space lounges offer two height choices 1200mm or 1600mm. Features non-removable cushions to ensure longevity the lounges in the unpredictable education environment.

Made with quality full fire retardant foam. GECA Certified and Australian made locally in NSW.

Optional Features:

- Two Tone Upholstery, available in any fabric colour to suit your colour scheme.
- Tall Back (1600H)
- 1, 2, 2.5, and 3 seater options
- Pixel PowerPoint

PLEASE NOTE: ALL PRICES ARE BASED ON NO FABRIC UNLESS OTHERWISE STATED.

| PRODUCT                     | DESCRIPTION          | FABRIC REQUIRED | DIMENSIONS           |
|-----------------------------|----------------------|-----------------|----------------------|
| <b>SHIELD STANDARD BACK</b> | Shield 1 Seater      | 8m              | 1200H x 750W x 760D  |
|                             | Shield 2 Seater      | 14.5m           | 1200H x 1350W x 760D |
|                             | Shield 3 Seater      | 20m             | 1200H x 1950W x 760D |
|                             |                      |                 |                      |
| <b>SHIELD TALL BACK</b>     | Shield Tall 1 Seater | 11m             | 1600H x 750W x 760D  |
|                             | Shield Tall 2 Seater | 17.5m           | 1600H x 1350W x 760D |
|                             | Shield Tall 3 Seater | 20m             | 1600H x 1950W x 760D |
|                             |                      |                 |                      |



### Specifications

Available in Any Fabric to suit you colour scheme

Refer to Page 14 for house Range, Caprio & Cashmere

Manufactured in Australia, within 5-6 Week lead time

Note: Custom two-toned upholstery orders (outside standard two-tone specifications) may incur additional charge.

Collaborative seating range not available for online ordering





# SOFT SEATING

## FLOW LOUNGE

Seat Height 450mmH x 500mmD



Flow modular seating is ideally formed in a large sitting area where teams work, relax or collaborate. Flow is an eye-catching design mounted on 120mm high chrome feet that shouts creativity. The standard back option with the addition of a matching ottoman provides an open invitation for group collaboration. The tall back alternative forms creative hubs for added seclusion, concentration and privacy.

### FEATURE HIGHLIGHTS

- Large range of modular configuration options
- Options to add rectangular shaped arms and matching ottoman
- Modern design with 120mm high feet
- Standard lead-time is 5-6 weeks from the order date
- Made in Australia

Please note: all prices are based on No fabric unless otherwise stated.

| PRODUCT                                                                             | DESCRIPTION           | FABRIC REQUIRED | DIMENSIONS           |
|-------------------------------------------------------------------------------------|-----------------------|-----------------|----------------------|
| <b>FLOW STANDARD BACK</b>                                                           |                       |                 |                      |
|  | Flow 1 Seater         | 2m              | 780H x 600W x 710D   |
|                                                                                     | Flow 2 Seater         | 3.1m            | 780H x 1200W x 710D  |
|                                                                                     | Flow 3 Seater         | 4.1m            | 780H x 1800W x 710D  |
|                                                                                     | Flow Corner           | 2.4m            | 780H x 710W x 710D   |
|                                                                                     | Flow 1 Seater w/ Arms | 3.8m            | 780H x 780W x 710D   |
|                                                                                     | Flow 2 Seater w/ Arms | 4.6m            | 780H x 1380W x 710D  |
|                                                                                     | Flow 3 Seater w/ Arms | 8.6m            | 780H x 1980W x 710D  |
| <b>FLOW TALL BACK</b>                                                               |                       |                 |                      |
|  | Flow Tall 1 Seater    | 11m             | 1200H x 600W x 710D  |
|                                                                                     | Flow Tall 2 Seater    | 17.5m           | 1200H x 1200W x 710D |
|                                                                                     | Flow Tall 3 Seater    | 23m             | 1200H x 1800W x 710D |





# SOFT SEATING

## CHOOSE YOUR FLOW LOUNGE

### FLOW STANDARD

Fabric A   Fabric B   Fabric C

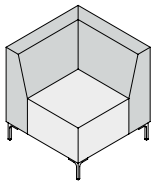

Corner Seater  
Standard Back

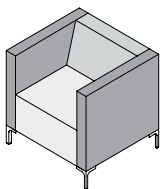

1 Seater  
Standard Back  
w/ Arms

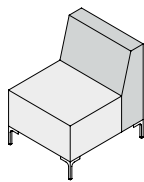

1 Seater  
Standard Back

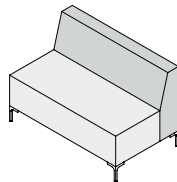

2 Seater  
Standard Back

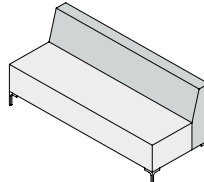

3 Seater  
Standard Back

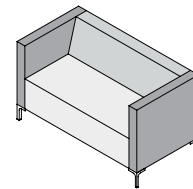

2 Seater  
Standard Back w/  
Arms

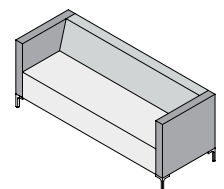

3 Seater  
Standard Back w/  
Arms

### FLOW TALL

Fabric A   Fabric B   Fabric C

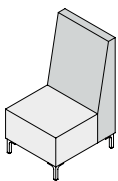

1 Seater  
Tall Back

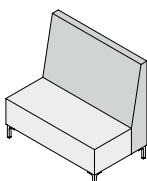

2 Seater  
Tall Back

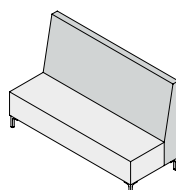

3 Seater  
Tall Back

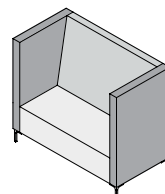

2 Seater  
Tall Back w/ Arms

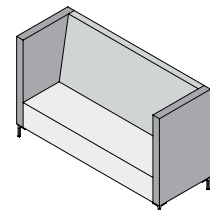

3 Seater  
Tall Back w/ Arms

#### Specifications

Available in Any Fabric to suit your colour scheme

Refer to Page 14 for house Range, Caprio & Cashmere

Manufactured in Australia, within 5-6 Week lead time

Note: Custom two-toned upholstery orders (outside standard two-tone specifications) may incur additional charge.

Collaborative seating range not available for online ordering



# SOFT SEATING

## PARK LOUNGE

Seat Height 450mmH x 555mmD



The versatility of Park makes it the perfect option for breakout spaces and ad-hoc meeting areas. Featuring a smooth aesthetic design and clever modular construction, Park offers multiple configurations to inspire imaginative workplaces. Position Park in a circle to define a team meeting area, or use independently by adding arms, a laptop table and a matching ottoman.

### FEATURE HIGHLIGHTS

- Versatile & modular layout
- Smooth aesthetic design
- Option to add arms & matching ottoman
- Standard lead-time is 5-6 weeks from the order date
- Made in Australia

PLEASE NOTE: ALL PRICES ARE BASED ON NO FABRIC UNLESS OTHERWISE STATED.

| PRODUCT                                                                                                          | DESCRIPTION                        | DIMENSIONS           |
|------------------------------------------------------------------------------------------------------------------|------------------------------------|----------------------|
| <b>PARK STANDARD BACK</b><br> | Park 1 Outer-Curve Ottoman (30°)   | 450H x 900W x 740D   |
|                                                                                                                  | Park 1.5 Outer-Curve Ottoman (45°) | 450H x 1300W x 740D  |
|                                                                                                                  | Park 1 Seater Standard Back        | 770H x 650W x 740D   |
|                                                                                                                  | Park 2 Seater Standard Back        | 770H x 1300W x 740D  |
|                                                                                                                  | Park 1 Seater Inner-Curve          | 770H x 900W x 740D   |
|                                                                                                                  | Standard Back (30°)                |                      |
|                                                                                                                  | Park 1 Seater Outer-Curve          | 770H x 900W x 740D   |
|                                                                                                                  | Standard Back (30°)                |                      |
|                                                                                                                  | Park 1.5 Seater Inner-Curve        | 770H x 1300W x 740D  |
|                                                                                                                  | Standard Back (45°)                |                      |
|                                                                                                                  | Park 1.5 Seater Outer-Curve        | 770H x 1300W x 740D  |
|                                                                                                                  | Standard Back (45°)                |                      |
|                                                                                                                  | Park Ottoman 650mm                 | 450H x 650W x 740D   |
|                                                                                                                  | Park Ottoman 1300mm                | 450H x 650W x 740D   |
| <b>PARK TALL BACK</b><br>     | Park 1 Seater Tall Back            | 1100H x 650W x 740D  |
|                                                                                                                  | Park 2 Seater Tall Back            | 1100H x 1300W x 740D |
|                                                                                                                  | Park 1 Seater Tall Inner-Curve     | 1100H x 900W x 740D  |
|                                                                                                                  | Standard Back (30°)                |                      |
|                                                                                                                  | Park 1 Seater Tall Outer-Curve     | 1100H x 900W x 740D  |
|                                                                                                                  | Standard Back (30°)                |                      |
|                                                                                                                  | Park 1.5 Seater Tall Inner-Curve   | 1100H x 1320W x 740D |
|                                                                                                                  | Standard Back (45°)                |                      |
|                                                                                                                  | Park 1.5 Seater Tall Outer-Curve   | 1100H x 1320W x 740D |
|                                                                                                                  | Standard Back (45°)                |                      |
| Park Corner Seater Tall Back RH                                                                                  | 1100H x 760W x 740D                |                      |
| Park Corner Seater Tall Back LH                                                                                  | 1100H x 760W x 740D                |                      |



# SOFT SEATING

## CHOOSE YOUR PARK COMPONENTS

### PARK STANDARD

Fabric A    Fabric B

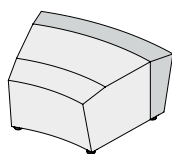

1 Seater  
Outer-Curve  
Ottoman

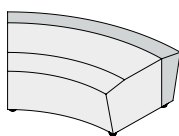

1.5 Seater  
Outer-Curve  
Ottoman

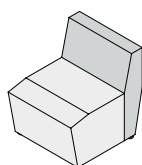

1 Seater  
Standard Back

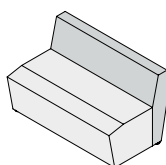

2 Seater  
Standard Back

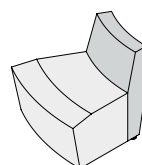

1 Seater  
Inner-Curve  
Standard Back  
(30 Degree)

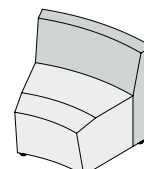

1 Seater  
Outer-Curve  
Standard Back  
(30 Degree)

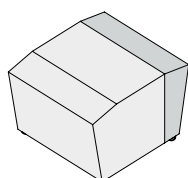

Ottoman  
650mmW

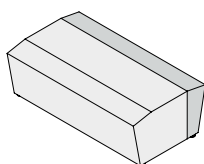

Ottoman  
1300mmW

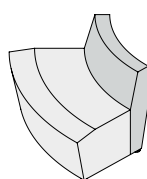

1.5 Seater  
Inner-curve  
Standard Back

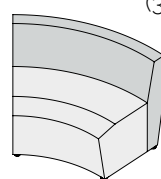

1.5 Seater  
Outer-curve  
Standard Back

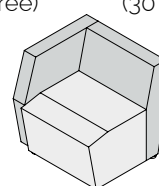

Corner Seat  
Standard Back -  
Left Hand

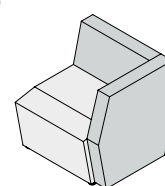

Corner Seat  
Standard Back -  
Right Hand

### PARK TALL

Fabric A    Fabric B    Fabric C

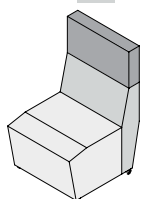

1 Seater  
Tall Back

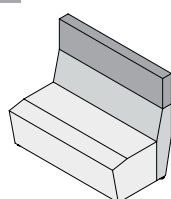

2 Seater  
Tall Back

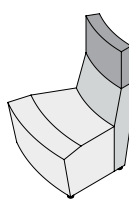

1 Seater  
Inner-Curve  
Tall Back  
(30 Degree)

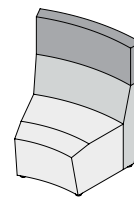

1 Seater  
Outer-Curve  
Tall Back  
(30 Degree)

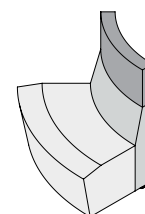

1.5 Seater  
Inner-curve  
Standard Back  
(45 Degree)

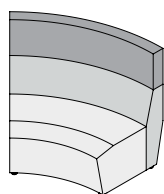

1.5 Seater  
Outer-curve  
Standard Back  
(45 Degree)

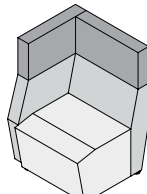

Corner Seat  
Tall Back -  
Right Hand

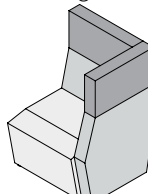

Corner Seat  
Tall Back -  
Left Hand

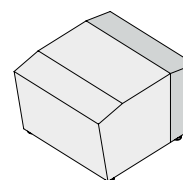

Ottoman  
650mmW

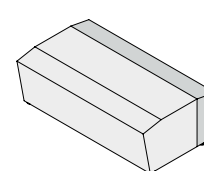

Ottoman  
1300mmW

#### Specifications

Available in Any Fabric to suit you colour scheme

Refer to Page 14 for house Range, Caprio & Cashmere

Manufactured in Australia, within 5-6 Week lead time

Note: Custom two-toned upholstery orders (outside standard two-tone specifications) may incur additional charge.

Collaborative seating range not available for online ordering



## QUIET BOOTH



Add a bit of private space to your open plan office. The phone booth is perfect for sensitive phone calls, working on confidential documents, or just a bit of peace and quiet.

### Standard Features:

- In stock in Grey/ White and Grey/ New Oak
- Toughened glass door
- Flat packed for easy moving and transportation, fits comfortably in most lifts
- Motion sensor, light, extraction fan, GPO & USB power outlet
- Made with acoustic panel that helps tune out noise
- 10 years warranty (excludes electrical components)
- Comes with bench to take notes or work on your laptop
- Internal walls absorb 75% of sound waves (100 fold reduction in sound intensity)

### Optional Features:

- Wireless fast charge in worktop
- Change outer e-panel colours: 4 weeks lead time
- Printing on white outer panel (includes artwork design & approval): 4 weeks lead time
- Glass door and/ or rear panel frosting (includes artwork design, work completed by sign maker after assembly)
- Window panel to back wall- special order: 12 weeks
- Box shelf upgrade (second shelf level and bag hook)- special order: 12 weeks

### PRODUCT

### DESCRIPTION

### DIMENSIONS

#### STANDARD QUIET BOOTH

|              |                       |
|--------------|-----------------------|
| New Oak/Grey | 2215H x 1100W x 1100D |
| White/Grey   | 2215H x 1100W x 1100D |

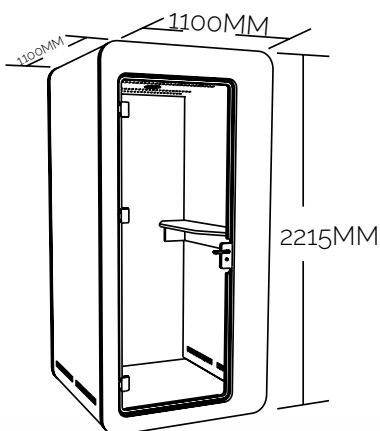

New Oak/Grey



White/Grey



# SOFT SEATING

## SARA SEATING



The Sara is a more modern take on our traditional booth range which encompasses the modern drive for style and sustainability. Made with non-removable cushions to ensure the longevity of the lounges in the unpredictable education environment.

Direct Ergonomics also offer a range of coffee tables/and or laptop tables to go with the lounges. GECA Certified and Australian made locally in NSW, made with quality fully fire retardant foam.

Optional Features:

- Two Tone Upholstery
- 1 or 2 seater options
- Multiple colour options available

| PRODUCT                   | DESCRIPTION     | FABRIC REQUIRED | DIMENSIONS           |
|---------------------------|-----------------|-----------------|----------------------|
| <b>Sara Standard Back</b> | Shield 1 Seater | 8m              | 1200H x 750W x 760D  |
|                           | Shield 2 Seater | 14.5m           | 1200H x 1350W x 760D |

Fabric A
 
 Fabric B

1 Seater

2 Seater

## ARC MOVEMENT

Highly customisable for any space



The ARC movement is our latest addition to our collaborative seating. The Arc is an clever group seating solution allowing twice the number of people to sit in the same amount of space as other booth seating of similar sizes.

Please talk to our sales team on 02 8437 5400 or email us at sales@directergo.com.au for information regarding possible arrangements, layouts, colours, fabrics and complementary seating options



| PRODUCT           | DESCRIPTION   | DIMENSIONS          |
|-------------------|---------------|---------------------|
| <b>Arc Custom</b> | Made to Order | Highly customisable |





# SOFT SEATING

## PEBBLE OTTOMAN



Collaborative space lounges offer two height choices 1200mm or 1600mm. Features non-removable cushions to ensure longevity the lounges in the unpredictable education environment.

Made with quality full fire retardant foam. GECA Certified and Australian made locally in NSW.

Optional Features:

- Two Tone Upholstery, available in any fabric colour to suit your colour scheme.
- Tall Back (1600H)
- 1, 2, 2.5, and 3 seater options
- Pixel PowerPoint

PLEASE NOTE: ALL PRICES ARE BASED ON NO FABRIC UNLESS OTHERWISE STATED.

| PRODUCT                     | DESCRIPTION         | FABRIC REQUIRED | DIMENSIONS           |
|-----------------------------|---------------------|-----------------|----------------------|
| <b>Shield Standard Back</b> | Pebble Seat         | 2.2m            | 650H x 450W x 450D   |
|                             | Pebble 450 Ottoman  | 1.5m            | 450H x 450W x 450D   |
|                             | Pebble 600 Ottoman  | 2m              | 450H x 600W x 600D   |
|                             | Pebble 900 Ottoman  | 3m              | 450H x 900W x 900D   |
|                             | Pebble 1200 Ottoman | 4m              | 450H x 1200W x 1200D |
|                             | Pebble 1500 Ottoman | 5.5m            | 450H x 1500W x 1500D |

Fabric A

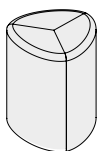

Pebble seat

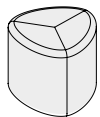

Ottoman 450

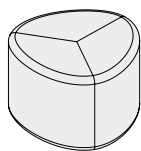

Ottoman 600

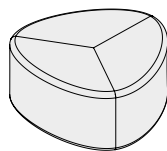

Ottoman 900

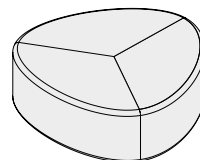

Ottoman 1200

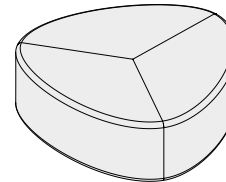

Ottoman 1500



Ottoman 1500mm



Ottoman 1200mm

### Specifications

Available in Any Fabric to suit your colour scheme

Refer to Page 14 for house Range, Caprio & Cashmere

Manufactured in Australia, within 5-6 Week lead time

Note: Custom two-toned upholstery orders (outside standard two-tone specifications) may incur additional charge.

Collaborative seating range not available for online ordering



# SOFT SEATING

## OTTA OTTOMAN MIX





The Otta shapes are quirky and fun, but also comfortable and practical. Easily moveable and taking up minimal room, these shapes are perfect for any collaborative space. Available in three different styles that can be used on their own or to compliment our other lounges and ottomans.

Available shapes:

- Round
- Square
- Bite

GECA certified and Australian made locally with fully fire-retardant foam. Can be upholstered in any fabric or vinyl to suit your colour scheme.

| PRODUCT                                                                                                     | DESCRIPTION               | FABRIC REQUIRED | DIMENSIONS           |
|-------------------------------------------------------------------------------------------------------------|---------------------------|-----------------|----------------------|
| <b>OTTA ROUND MIX</b><br> | Otta Round 450            | 1.7m            | 450H x 450W x 450D   |
|                                                                                                             | Otta Round 500            | 2.1m            | 450H x 500W x 500D   |
|                                                                                                             | Otta Round 600            | 2.4m            | 450H x 600W x 600D   |
|                                                                                                             | Otta Round 900            | 2.9m            | 450H x 900W x 900D   |
|                                                                                                             | Otta Round 1200           | 3.2m            | 450H x 1200W x 1200D |
|                                                                                                             | Otta Round 1500           | 3.9m            | 450H x 1500W x 1500D |
|                                                                                                             | Otta Bite 600             | 1.7m            | 450H x 600W x 600D   |
|                                                                                                             | Otta Curve 1200           | 2.2m            | 450Hx1200Wx770/700D  |
|                                                                                                             | Otta Curve 1500           | 3.2m            | 450Hx1500Wx800/700D  |
|                                                                                                             | Otta Curve 1800           | 3.6m            | 450Hx1800Wx830/700D  |
|                          | Otta Curve 2100           | 4.1m            | 450Hx2100Wx860/700D  |
|                                                                                                             | Otta Curve 2400           | 4.1m            | 450Hx2400Wx890/700D  |
|                                                                                                             | Otta Curve 2700           | 4.6m            | 450Hx2700Wx920/700D  |
|                                                                                                             | Otta Curve Seat & Back 12 | 3.3m            | 820Hx1200Wx770/700D  |
|                                                                                                             | Otta Curve Seat & Back 15 | 3.8m            | 820Hx1500Wx800/700D  |
|                                                                                                             | Otta Curve Seat & Back 18 | 4.4m            | 820Hx1800Wx830/700D  |
|                                                                                                             | Otta Curve Seat & Back 21 | 5.2m            | 820Hx2100Wx860/700D  |
|                                                                                                             | Otta Curve Seat & Back 24 | 5.7m            | 820Hx2400Wx890/700D  |
|                                                                                                             | Otta Curve Seat & Back 27 | 6.3m            | 820Hx2700Wx920/700D  |



 Fabric A  Fabric B

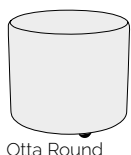

Otta Round

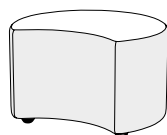

Otta Bite

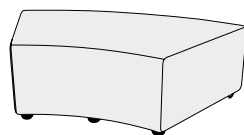

Otta Curve

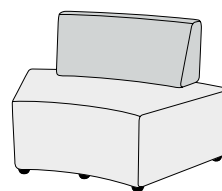

Otta Curve Seat & Back

### Specifications

Available in Any Fabric to suit your colour scheme

Refer to Page 14 for house Range, Caprio & Cashmere

Manufactured in Australia, within 5-6 Week lead time

Note: Custom two-toned upholstery orders (outside standard two-tone specifications) may incur additional charge.

Collaborative seating range not available for online ordering



# SOFT SEATING

## VERA LOUNGE

Pre-made for short Lead time



Elegant reception area three seater arm chair with button finish to black PU, easy clean upholstery. Stainless steel underframe and legs.

Features:

- Button Finish
- Stainless Steel Frame
- SGS: EN12520 Certification
- Overall Height - 750mm
- Overall Depth - 730mm

| DESCRIPTION | DIMENSIONS          |
|-------------|---------------------|
| 1 Seater    | 420H x 630W x 760D  |
| 2 Seater    | 420H x 1120W x 760D |
| 3 Seater    | 420H x 1770W x 500D |



## SAMAL LOUNGE

Locally Upholstered to match any space



The Perfect Match For Any recetion or Lunch Room, Customisable in any local fabric to match your space

Features:

- Pocket spring seat
- Loose cushions upholstered both sides
- Zig zag steel spring
- Webbed base
- Solid hardwood frame
- Stainless steel feet
- Available in all local fabrics



| DESCRIPTION | FABRIC REQUIRED | DIMENSIONS          |
|-------------|-----------------|---------------------|
| 1 Seater    | 4.5m            | 320H x 570W x 790D  |
| 2 Seater    | 6.8m            | 320H x 1130W x 790D |
| 3 Seater    | 9.3m            | 320H x 1690W x 790D |







# STORAGE



|                           |     |
|---------------------------|-----|
| Melamine Fixed Storage    | 123 |
| Melamine Mobile Storage   | 124 |
| Melamine Vertical Storage | 125 |
| Metal Mobile Storage      | 126 |
| Steel Stationary Storage  | 127 |
| Steel Filing Cabinet      | 128 |
| Steel Lockers             | 129 |



# STORAGE

## WORKZONE MELAMINE STORAGE

Bulk Storage & Personal Storage  
**CUSTOM SIZES AVAILABLE ON REQUEST**



| PRODUCT             | DESCRIPTION                                                  | DIMENSIONS          |  |
|---------------------|--------------------------------------------------------------|---------------------|--|
|                     | <b>CREDENZA</b>                                              | 720H x 900W x 450D  |  |
|                     |                                                              | 720H x 1200W x 450D |  |
|                     |                                                              | 720H x 1500W x 450D |  |
|                     |                                                              | 720H x 1800W x 450D |  |
|                     |                                                              | 900H x 900W x 450D  |  |
|                     |                                                              | 900H x 1200W x 450D |  |
|                     |                                                              | 900H x 1500W x 450D |  |
|                     | <b>CUPBOARD</b><br>(includes Adjustable Shelves as Standard) | 900W x 720H x 450D  |  |
|                     |                                                              | 900W x 900H x 450D  |  |
|                     |                                                              | 900W x 1200H x 450D |  |
|                     |                                                              | 900W x 1500H x 450D |  |
|                     |                                                              | 900W x 1800H x 450D |  |
|                     |                                                              | 900W x 2000H x 450D |  |
|                     |                                                              | 900W x 900H x 600D  |  |
|                     |                                                              | 900W x 1200H x 600D |  |
|                     |                                                              | 900W x 1500H x 600D |  |
|                     |                                                              | 900W x 1800H x 600D |  |
| 900W x 2100H x 600D |                                                              |                     |  |
| Add Lock to doors   |                                                              |                     |  |
|                     | <b>BOOKCASE</b><br>(includes Adjustable Shelves as Standard) | 900H x 900W x 320D  |  |
|                     |                                                              | 1200H x 900W x 320D |  |
|                     |                                                              | 1500H x 900W x 320D |  |
|                     |                                                              | 1800H x 900W x 320D |  |
|                     |                                                              | 720H x 900W x 450D  |  |
|                     |                                                              | 900H x 900W x 450D  |  |
|                     |                                                              | 1200H x 900W x 450D |  |
|                     |                                                              | 1500H x 900W x 450D |  |
|                     |                                                              | 1800H x 900W x 450D |  |
|                     |                                                              | 720H x 900W x 320D  |  |
|                     |                                                              | 720H x 1200W x 320D |  |
|                     |                                                              | 720H x 1800W x 320D |  |
|                     |                                                              | 720H x 1200W x 450D |  |
| 720H x 1800W x 450D |                                                              |                     |  |

\* PRICES BASED OFF WHITE, STANDARD MELAMINE COLOUR RANGE  
 SURCHARGE & MANUFACTURING TIME WILL APPLY









# STORAGE

## MELAMINE MOBILE STORAGE

Bulk Storage & Personal Storage



| PRODUCT                                                                             | DESCRIPTION                                                    | DIMENSIONS         |
|-------------------------------------------------------------------------------------|----------------------------------------------------------------|--------------------|
|    | <b>MOBILE DRAWER UNIT</b><br>4 Box Drawer                      | 600H x 600W x 460D |
|    | <b>MOBILE DRAWER UNIT</b><br>1 File & 2 Box Drawers            | 600H x 400W x 500D |
|   | <b>MOBILE DRAWER UNIT</b><br>2 File drawer                     | 675H x 467W x 610D |
|  | <b>MOBILE BOOKCASE CADDY UNIT</b><br>1 Adjustable Shelf        | 600H x 858W x 500D |
|  | <b>MOBILE CADDY UNIT</b><br>1 Tambour Unit,<br>1 Drawer insert | 640H x 994W x 460D |
|  | <b>MOBILE BOOKCASE UNIT</b><br>1 Adjustable Shelf              | 600H x 440W x 500D |
|  | <b>MOBILE BOOKCASE DRAWER UNIT</b><br>Non-Locking              | 100H x 400W x 470D |



\* Prices Based Off White, Standard Melamine Colour Range on Page 12, surcharge & Manufacturing time will apply







# STORAGE

## MELAMINE MOBILE STORAGE

Bulk Storage & Personal Storage



| PRODUCT                                                                             | DESCRIPTION                                                          | DIMENSIONS          |
|-------------------------------------------------------------------------------------|----------------------------------------------------------------------|---------------------|
|    | <b>VERTICAL FILING CABINET</b><br>2 Drawer                           | 720H x 465W x 600D  |
|    | <b>VERTICAL FILING CABINET</b><br>3 Drawer                           | 1050H x 465W x 600D |
|   | <b>VERTICAL FILING CABINET</b><br>4 x File Drawers                   | 1400H x 994W x 460D |
|  | <b>VERTICAL CABINET</b><br>2 Microwave Pockets w/<br>2 door cupboard | 750W x 2100H x 600D |
|  | <b>DESKTOP SHELF</b>                                                 | 600 mm W            |



\* Prices Based Off White, Standard Melamine Colour Range on Page 12, surcharge & Manufacturing time will apply











# STORAGE

## WORKZONE STEEL STORAGE

Mobile & Caddy Mobiles



| PRODUCT                                                                             | DESCRIPTION                                                                                                     | DIMENSIONS         |
|-------------------------------------------------------------------------------------|-----------------------------------------------------------------------------------------------------------------|--------------------|
|    | <b>MOBILE DRAWERS</b><br>Two Box Drawers + One File<br>Drawer - Gang Locking                                    | 600H x 470W x 460D |
|    | <b>MOBILE DRAWERS</b><br>Four Box Drawers<br>Gang Lock                                                          | 640H x 470W x 460D |
|    | <b>CADDY MOBILE BOOKCASE</b><br>2 x Adjustable Shelves                                                          | 640H x 994W x 460D |
|   | <b>CADDY MOBILE BOOKCASE</b><br>1 x Drawer Insert<br>Left or Right handed<br>Configuration                      | 640H x 994W x 460D |
|  | <b>CADDY MOBILE</b><br>2 x Drawer Insert                                                                        | 640H x 994W x 460D |
|  | <b>CADDY MOBILE BOOKCASE</b><br>1 x Tambour Insert<br>Left or Right handed<br>Configuration                     | 640H x 994W x 460D |
|  | <b>CADDY MOBILE BOOKCASE</b><br>1 x Tambour Insert<br>1x Drawer Insert<br>Left or Right handed<br>Configuration | 640H x 994W x 460D |
|  | <b>CADDY MOBILE</b><br>2 x Tambour Insert                                                                       | 640H x 994W x 460D |
|  | <b>OPTIONAL ADD ON</b><br>Seat Toppa<br>Upholstered, Sewn all four<br>sides                                     | 470H x 460W x 40D  |











# STORAGE

## WORKZONE STEEL STORAGE

Tower Storage, Tambours & Planter



| PRODUCT                                                                             | DESCRIPTION                                                                                       | DIMENSIONS           |
|-------------------------------------------------------------------------------------|---------------------------------------------------------------------------------------------------|----------------------|
|    | <b>LARGE STATIONARY CABINET</b><br>2 x Adjustable Shelves,<br>180 Deg. opening Doors,<br>Lockable | 1015H x 910W x 450D  |
|    | <b>LARGE STATIONARY CABINET</b><br>3 x Adjustable Shelves,<br>180 Deg. opening Doors,<br>Lockable | 1830H x 910W x 450D  |
|    | <b>LARGE STATIONARY CABINET</b><br>4 x Adjustable Shelves,<br>180 Deg. opening Doors,<br>Lockable | 2000H x 910W x 450D  |
|  | <b>TAMBOUR UNIT</b><br>2 x Adjustable Shelves                                                     | 1016H x 1200W x 473D |
|  | <b>TAMBOUR UNIT</b><br>2 x Adjustable Shelves                                                     | 1200H x 1200W x 473D |
|  | <b>TAMBOUR UNIT</b><br>5 x Adjustable Shelves                                                     | 1981H x 1200W x 473D |
|  | <b>TAMBOUR UNIT</b><br>2 x Adjustable Shelves                                                     | 1016H x 900W x 473D  |
|  | <b>TAMBOUR UNIT</b><br>2 x Adjustable Shelves                                                     | 1200H x 900W x 473D  |
|  | <b>TAMBOUR UNIT</b><br>5 x Adjustable Shelves                                                     | 1981H x 900W x 473D  |















# STORAGE

## WORKZONE STEEL STORAGE

Tower Storage, Tambours & Planter











| PRODUCT                                                                             | DESCRIPTION                                                                                                   | DIMENSIONS           |
|-------------------------------------------------------------------------------------|---------------------------------------------------------------------------------------------------------------|----------------------|
|    | <b>VERTICAL FILING CABINET</b><br>2 x File Drawers                                                            | 705H x 460W x 620D   |
|    | <b>VERTICAL FILING CABINET</b><br>3 x File Drawers                                                            | 1016H x 460W x 620D  |
|    | <b>VERTICAL FILING CABINET</b><br>4 x File Drawers                                                            | 1321H x 460W x 620D  |
|    | <b>LATERAL FILING CABINET</b><br>2 x File Drawers                                                             | 705H x 900W x 473D   |
|   | <b>LATERAL FILING CABINET</b><br>3 x File Drawers                                                             | 1016H x 900W x 473D  |
|  | <b>LATERAL FILING CABINET</b><br>4 x File Drawers                                                             | 1321H x 900W x 473D  |
|  | <b>PLANTER BOX</b><br>to Suit Tambour & Lateral Filing cabinets - Includes Drip Tray - 3 x 200mm Dia Cut Outs | 230H x 900W x 473D   |
|  | <b>PLANTER BOX</b><br>to Suit Tambour & Lateral Filing cabinets - Includes Drip Tray - 3 x 200mm Dia Cut Outs | 230H x 1200W x 473D  |
|  | <b>PLANTER WALL</b><br>includes plants, pots, stones                                                          | 2000H x 1000W x 200D |
|  | <b>HEAVY DUTY SHELVING</b><br>50kg Per shelf, 5 shelves incl                                                  | 1830H x 914W x 457D  |



# STORAGE

## WORKZONE PERSONAL LOCKERS



| PRODUCT                                                                             | DESCRIPTION                                                                                                                                  | DIMENSIONS                                 |
|-------------------------------------------------------------------------------------|----------------------------------------------------------------------------------------------------------------------------------------------|--------------------------------------------|
|    | <b>PERSONAL STORAGE CABINET</b><br>2 x Adjustable Shelves, 1x Hanging Rail<br>180 Deg. opening Doors,<br>Lockable                            | 1015H x 910W x 450D                        |
|    | <b>PERSONAL STORAGE CABINET</b><br>3 x Adjustable Shelves, 1x Hanging Rail<br>180 Deg. opening Doors,<br>Lockable                            | 1830H x 910W x 450D                        |
|    | <b>PERSONAL STORAGE CABINET</b><br>4 x Adjustable Shelves, 1x Hanging Rail<br>180 Deg. opening Doors,<br>Lockable                            | 2000H x 910W x 450D                        |
|   | <b>HALF HEIGHT LOCKER</b><br>Fully Welded<br>Australian Made<br>Multiple Locking options<br>Can be banked upto 3 units                       | 950H x 300W x 450D                         |
|  | <b>SINGLE TIER LOCKER</b><br>Full Length Stiffeners Fitted To Every Door Name Tag Holder, Vented Doors, Coat Rail & Hat Shelf                | 1830H x 305W x 455D<br>1830H x 380W x 455D |
|  | <b>TWO TIER LOCKER</b><br>Full Length Stiffeners Fitted To Every Door<br>Name Tag Holder, Vented Doors, 2 x Coat Hooks In Each Compartment   | 1830H x 305W x 455D<br>1830H x 380W x 455D |
|  | <b>THREE TIER LOCKER</b><br>Full Length Stiffeners Fitted To Every Door<br>Name Tag Holder, Vented Doors, 2 x Coat Hooks In Each Compartment | 1830H x 380W x 455D                        |
|  | <b>FOUR TIER LOCKER</b><br>Full Length Stiffeners Fitted To Every Door Name Tag Holder, Vented Doors, Shelf Fitted To Each Compartment       | 1830H x 305W x 455D<br>1830H x 380W x 455D |
|  | <b>FIVE TIER LOCKER</b><br>Full Length Stiffeners Fitted To Every Door Name Tag Holder, Vented Doors, Shelf Fitted To Each Compartment       | 1830H x 380W x 455D                        |



# ENDLESS CONNECTIVITY



# COMPONENTS





|                        |     |
|------------------------|-----|
| Worktops               | 132 |
| Cable Management       | 133 |
| Power & Data Solutions | 134 |

# ERGONOMIC ACCESSORIES

## WORKTOPS

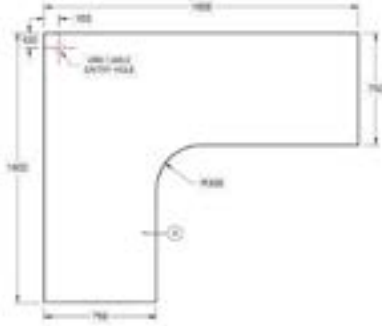
Standard In Stock Worktops in White Laminate







| PRODUCT                                                                             | DESCRIPTION                                  | DIMENSIONS           |
|-------------------------------------------------------------------------------------|----------------------------------------------|----------------------|
|    | STRAIGHT WORKTOP                             | 1200W x 750D         |
|                                                                                     | STRAIGHT WORKTOP                             | 1500W x 750D         |
|                                                                                     | STRAIGHT WORKTOP                             | 1800W x 750D         |
|   | CORNER WORKTOP                               | 1500W x 1800W x 750D |
|                                                                                     | CORNER WORKTOP                               | 1800W x 1800W x 750D |
|                                                                                     | CORNER WORKTOP                               | 2100W x 1800W x 750D |
|  | MEETING WORKTOP                              | 1800W x 900D         |
|                                                                                     | MEETING WORKTOP                              | 1800W x 1200D        |
|                                                                                     | MEETING WORKTOP                              | 2100W x 900D         |
|                                                                                     | MEETING WORKTOP                              | 2100W x 1200D        |
|  | <b>ADD CABLE SCOOP</b><br>To any worktop     |                      |
|                                                                                     | <b>ADD ROUNDED CORNER</b><br>To any worktop  |                      |
|                                                                                     | <b>ADD CABLEBOX CUTOUT</b><br>To any worktop | Non ABS edging       |
|                                                                                     | <b>ADD CABLEBOX CUTOUT</b><br>To any worktop | includes ABS edging  |



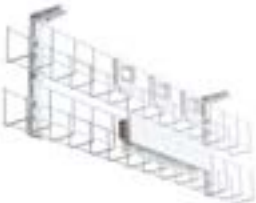

## CABLE MANAGEMENT

Keep Cables tidy & hidden











| PRODUCT                                                                             | DESCRIPTION                                         | DIMENSIONS                                    |
|-------------------------------------------------------------------------------------|-----------------------------------------------------|-----------------------------------------------|
|    | Cable Shute<br>Height Adjustable Kit Desk           | 750mm, 2 X Fixing Brackets                    |
|    | Trax Umbilical<br>Height Adjustable Kit Desk        | 1400mm, Cable Tray to workstation             |
|    | <b>POWERPOLE</b><br>ceiling to workstation          | 2100H pipeline kit                            |
|  | <b>CIRCULATE UMBILICAL</b><br>ceiling to floor      | 2100mm Ceiling-Desk<br>Kit With Mounting Foot |
|                                                                                     | <b>CABLE BASKET</b><br>2 tier (Stacked)             | 1250mmW x 206.6mmH                            |
|  | <b>CABLE BASKET</b><br>2 tier (Stacked)             | 1550mmW x 206.6mmH                            |
|                                                                                     | <b>CABLE BASKET</b><br>2 tier (Stacked)             | 1850mmW x 206.6mmH                            |
|                                                                                     | <b>ANGLED CABLE DUCT</b><br>with Metal Lid          | to suit B2B 1500W Workstations                |
|  | <b>ANGLED CABLE DUCT</b><br>with Metal Lid          | to suit B2B 1500W Workstations                |
|                                                                                     | <b>ADD SERVICES CUTOUTS</b><br>to angled cable duct | 4 GPO, 2 Data                                 |



# ERGONOMIC ACCESSORIES

## POWER, DATA & CHARGING

Solutions to deliver Power, or Quick access for de-

| PRODUCT                                                                             | DESCRIPTION                                                 | DIMENSIONS                                           |
|-------------------------------------------------------------------------------------|-------------------------------------------------------------|------------------------------------------------------|
|    | <b>SERVICE FOR CABLE DUCT</b><br>Add on services            | 4 GPO, 2 Data                                        |
|    | <b>SERVICE FOR CABLE BASKET</b><br>Add on services          | 4 GPO, 2 Data                                        |
|    | <b>ATHENA RAIL</b><br>1 X GPO And Inline USB-A/C            | 1 X GPO And Inline USB-A/C<br>With Quick Charge Port |
|    | <b>ATHENA RAIL</b><br>2 X GPO And Inline USB-A/C            | 2 X GPO And Inline USB-A/C<br>With Quick Charge Port |
|  | <b>ATHENA RAIL</b><br>4 X GPO And Inline USB-A/C            | 4 X GPO And Inline USB-A/C<br>With Quick Charge Port |
|  | <b>KONEXUS - PIXEL</b><br>Workstation, Soft Seating         | 1 GPO, 2 USB                                         |
|  | <b>FLUSH MOUNTED CABLE-</b>                                 | 2 GPO, 2 USB                                         |
|  | <b>BLINKY DESKTOP MOUNTED</b><br>GPO & USB A/C Quick charge | USB Type-C/A fast-charge, 500mm TAG lead             |
|  | <b>ACCEDES SINGLE LID</b><br>GPO, Data & AV                 | 2 GPO, Provision For 2 X<br>Data, 1 X Module For AV  |
|  | <b>ACCEDES CABLE BOX</b><br>Flush mounted                   | 8 GPO, 8 Data Provisions                             |







# DIRECT ERGONOMICS

## **SYDNEY**

30-32 Hotham Parade  
Artarmon NSW 2064  
ph. 02 8437 5400

## **MELBOURNE**

18 - 20 Brooklyn Court,  
Campbellfield VIC 3061

## **CANBERRA**

Coming Soon

## **CONTACT US**

[SALES@DIRECTERGO.COM.AU](mailto:SALES@DIRECTERGO.COM.AU)

[WWW.DIRECTERGO.COM.AU](http://WWW.DIRECTERGO.COM.AU)