

2026

WORKZONE TECHNICAL SHEET

DIRECT ERGONOMICS



DIRECTERGO.COM.AU | SALES@DIRECTERGO.COM.AU



WORKZONE ELECTRIC

PRODUCT SPECIFICATION



Forgetting the hype and sticking to the facts, our range of Sit-to-Stand desks comply to Australian Standards, are AFRDI tested and approved, GECA Certification plus a 10-year warranty.

Now remember, once you have a Sit-to-Stand desk, get up and out of your chair and stand up for a portion of your day, be it for an hour or two, then sit back down again – Mix it up!

SIZING GUIDE	WIDTH	DEPTH	HEIGHT	LEG DIMENSION
• Straight Desk	1200-2100mm	600-900mm	610-1280mm	70x70mm or 70 Dia
• Corner Desk	1200-2100mm	600-900mm	610-1280mm	70x70mm or 70 Dia
• Back to Back Desk	1200-2100mm	600-900mm	610-1280mm	70x70mm or 70 Dia

STANDARD FEATURES

- Complies to ASNZS4442 for Office Desks & ASNZ4443 for Workstations
- Adjustment speed 55mm/per second
- Motor(s) are thermal and overload protected: for safety and longevity
- Concealed motors in each leg
- Fast assembly system - less than 3 minutes
- 3 programmable height memory buttons with LCD readout
- Telescopic beams, means as your space grows or shrinks so you can change the worktop to suit
- Single straight, corner frame or double sided straight desk (H-frame)
- Charge ready USB-A & USB-C port on handset
- Programmable to restrict min/max height + anti-collision sensitivity
- Weight capacity:
 - Straight frame - 130kg
 - Corner frame - 160kg
- 10-year warranty
- GECA Certified
- Height range 610-1280mm AFRDI Certified – (including 25mm worktop)
 - straight, corner and B2B
- GreenTag Certified
- Product stewardship at end of life

STANDARD LAMINATES

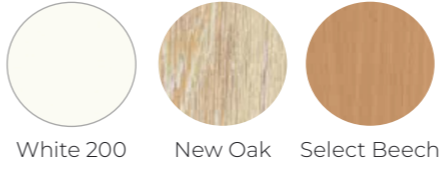

STANDARD POWDERCOAT

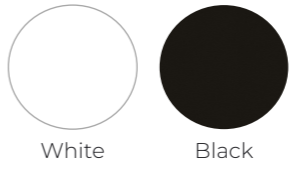

EXTENDED FINISH OPTIONS

- Worktops:
 - Laminex & Formica ranges
 - Contrast edging available
- Frames:
 - Custom powdercoat

PRIVACY OPTIONS

- Screens:
 - Aero 50mm (Upholstered Framed)
 - Cube 30mm (Upholstered Framed)
 - Blade Upholstered (Frameless)
 - Eco Acoustic Family (Frameless, Recycled PET)

WORKZONE ELECTRIC FRAME PROFILES



Workzone Electrics is a premium leg desking solution that elevates and supports people in Australian businesses every day. This workstation system is our bread and butter, constantly improving the design over the years to become a market leader today and into the future!

The frame design offers two versions; our default is the standard Square shape, but as offices become places to inspire employees, we have recently launched a rounded leg profile to add an organic look to the desk frame.

SQUARE SHAPE



ROUND SHAPE



WORKZONE ELECTRIC PRODUCT CONFIGURATIONS



STRAIGHT DESKS

- Width Range: 1400-2100mm
- Depth Range: 600-900mm
- Height Range: 610-1280mm



Single

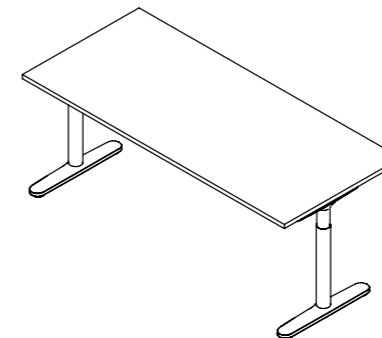

Back-To-Back

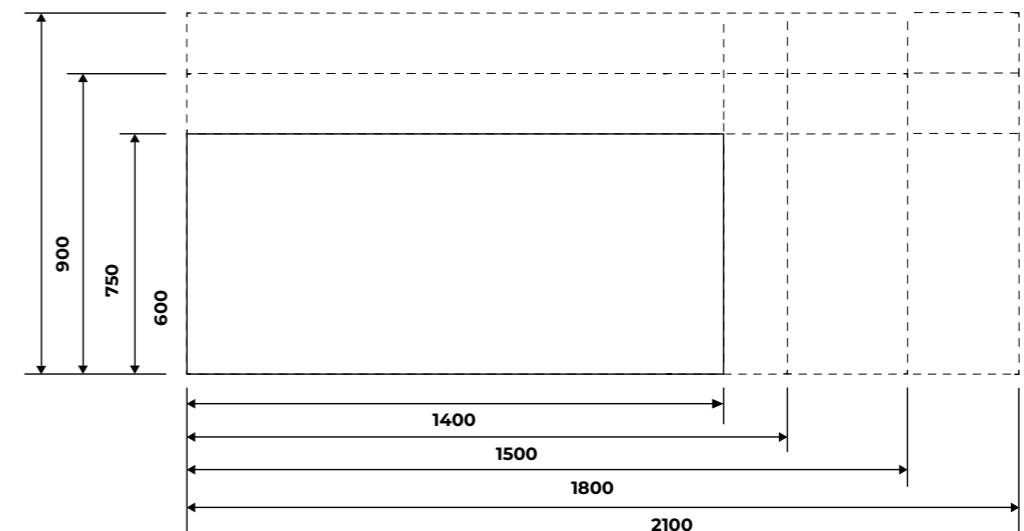
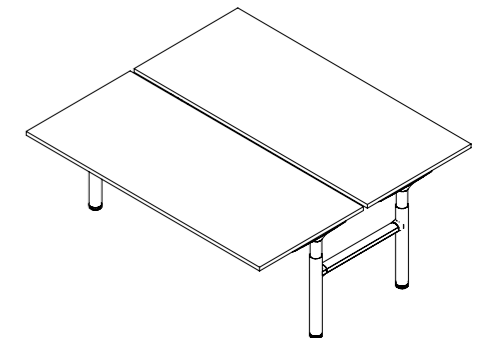

WORKZONE ELECTRIC

PRODUCT CONFIGURATIONS



120 DEGREE DESKS

- Width Range: 1200-1600mm
- Depth Range: 600-750mm
- Height Range: 610-1280mm



Single

3 Way

3 Way Sector

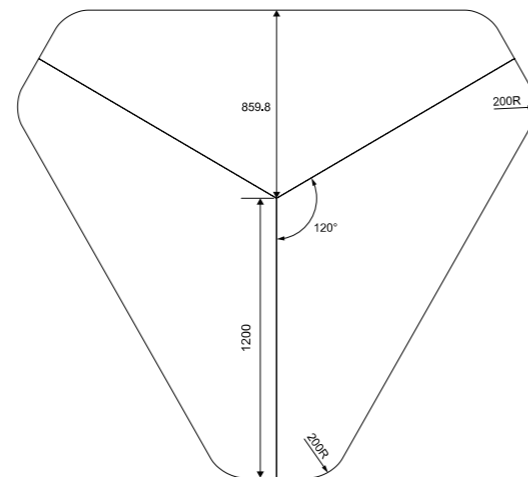
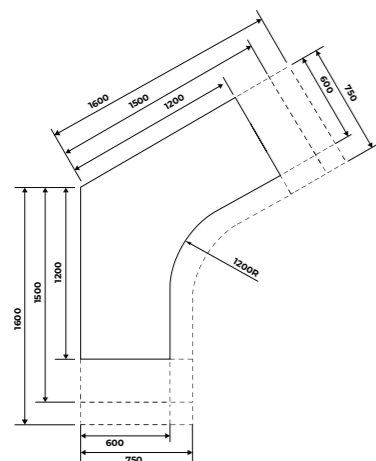
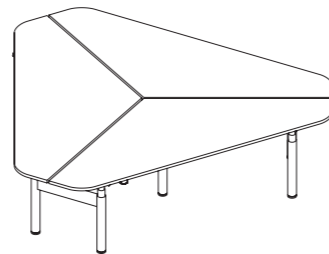
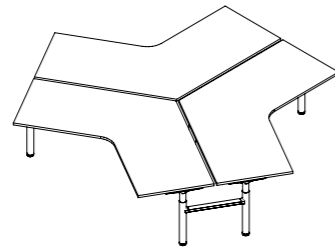
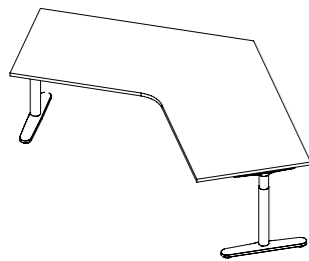

WORKZONE ELECTRIC

PRODUCT CONFIGURATIONS



CORNER DESKS

- Width Range: 1200-1800mm
- Depth Range: 600-750mm
- Height Range: 610-1280mm



Single

Back-To-Back

4 Way

4 Way Quadrant

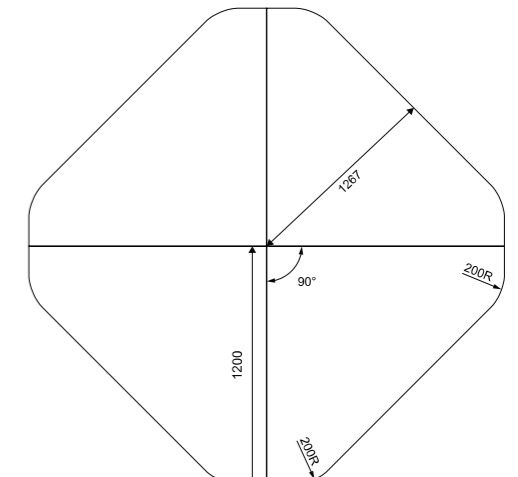
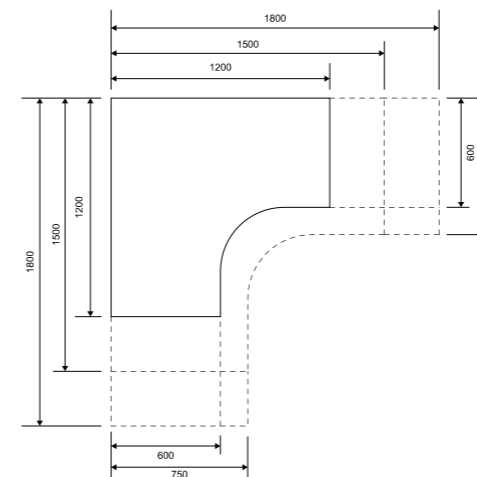
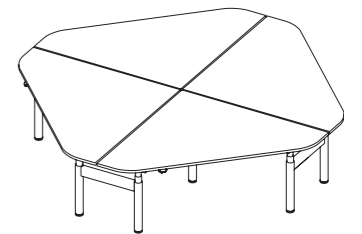
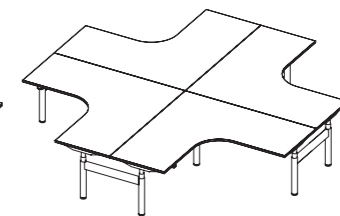
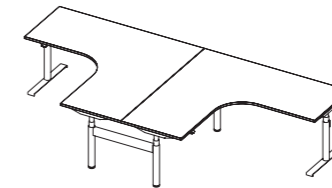
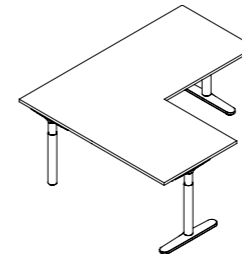

WORKZONE ELECTRIC

CABLE MANAGEMENT



CABLE TRAY MOUNTED SERVICES



- Concealed wires/ services
- Segregated power and data
- Power outlets and data points can be configured to your requirements
- Available in back-to-back, corner and freestanding straight configurations

DESKTOP MOUNTED CABLE MANAGEMENT

Single Tier Cable Basket

Dual Tier Cable Basket

Cable Sock

Umbilical

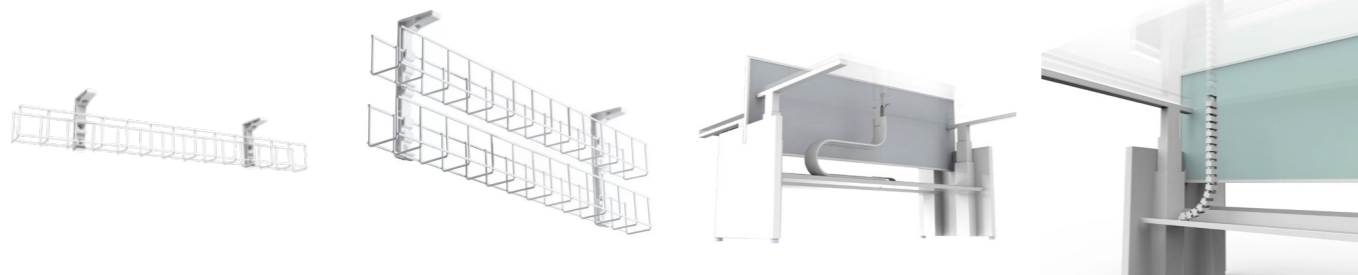

VERTICAL RETICULATION

Power Pole

Umbilical



WORKZONE ELECTRIC

SERVICES



DESKTOP MOUNTED SERVICES

Athena Rail



Nova & Viva Rails



Echo in-desk



Atom In-Desk



Atom Under-Desk



KonexUS in-desk



CABLE TRAY MOUNTED SERVICES

Power Outlets



Singular Data Outlets



Double Data Outlets



WORKZONE ELECTRIC PRIVACY - STYLES



BELOW DESK MODESTY

MFI - Laminated Modesty



Workzone - Metal Modesty

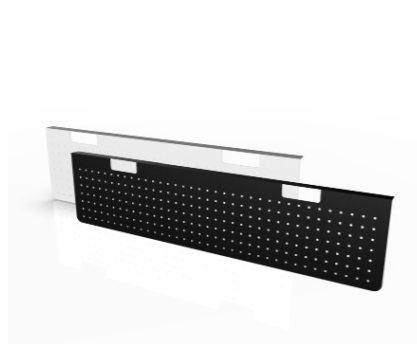

Eco - Modesty Panel



ABOVE DESK PRIVACY

Aero - Desktop Mounted



Aero - Fixed Height



Aero - Cable Tray Mounted



Cube - Desktop Mounted

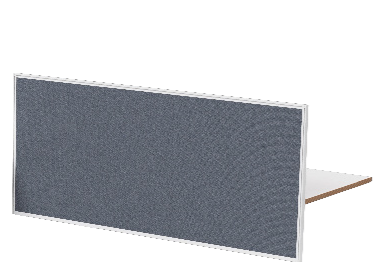

Cube - Fixed Height



Cube - Cable Tray Mounted



WORKZONE ELECTRIC PRIVACY - MOUNTING TYPES



ECO ACOUSTIC SCREEN

Straight Desktop Mounted

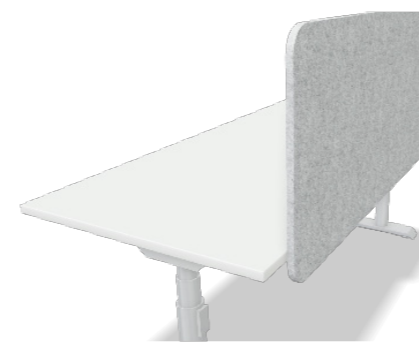

Wrapped Desktop Mounted



Straight Cable Tray Mounted

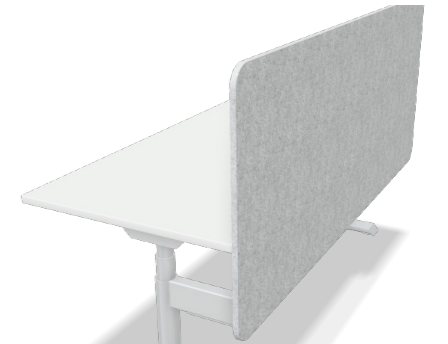

BLADE UPHOLSTERED SCREEN

Straight Desktop Mounted

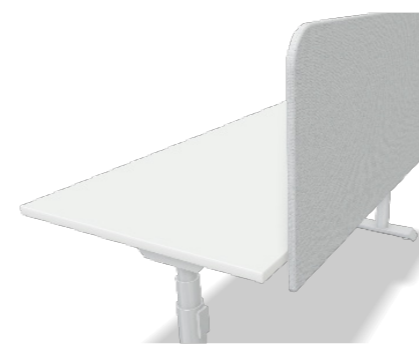

Wrapped Desktop Mounted

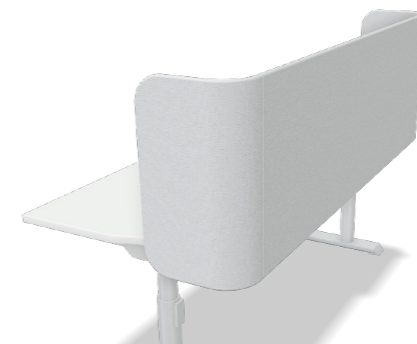

Straight Cable Tray Mounted

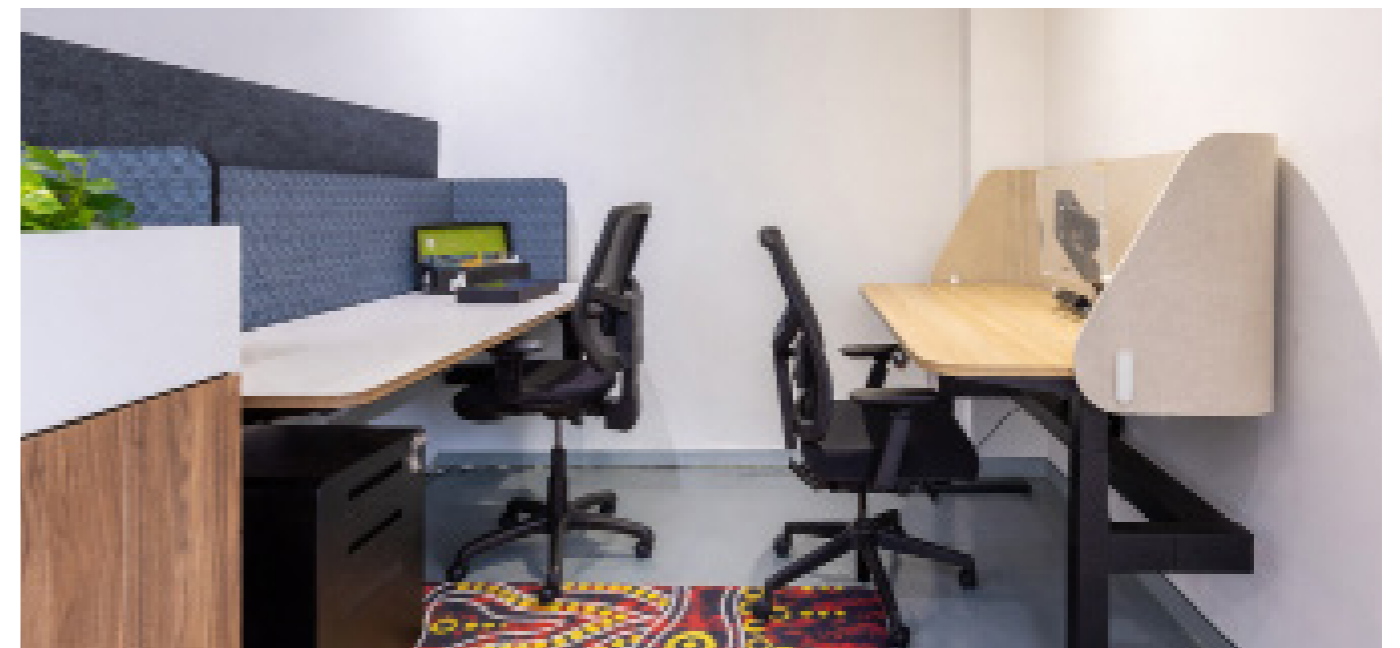



CONTACT US

P: 02 8437 5400

E: SALES@DIRECTERGO.COM.AU

A: 30-32 HOTHAM PARADE, ARTARMON, NSW 2064

W: www.directergo.com.au

SYDNEY | MELBOURNE | CANBERRA

